

# R&S® SFE100 Test Transmitter Getting Started



致力于电子测试、维护领域!



2112.4122.62 - 13



北京海洋兴业科技股份有限公司 (证券代码: 839145)

电话: 010-62176785

网址: [www.hyxyyq.com](http://www.hyxyyq.com)

Getting Started

# Basic Safety Instructions

## Always read through and comply with the following safety instructions!

All plants and locations of the Rohde & Schwarz group of companies make every effort to keep the safety standards of our products up to date and to offer our customers the highest possible degree of safety. Our products and the auxiliary equipment they require are designed, built and tested in accordance with the safety standards that apply in each case. Compliance with these standards is continuously monitored by our quality assurance system. The product described here has been designed, built and tested in accordance with the EC Certificate of Conformity and has left the manufacturer's plant in a condition fully complying with safety standards. To maintain this condition and to ensure safe operation, you must observe all instructions and warnings provided in this manual. If you have any questions regarding these safety instructions, the Rohde & Schwarz group of companies will be happy to answer them.







Furthermore, it is your responsibility to use the product in an appropriate manner. This product is designed for use solely in industrial and laboratory environments or, if expressly permitted, also in the field and must not be used in any way that may cause personal injury or property damage. You are responsible if the product is used for any purpose other than its designated purpose or in disregard of the manufacturer's instructions. The manufacturer shall assume no responsibility for such use of the product.

The product is used for its designated purpose if it is used in accordance with its product documentation and within its performance limits (see data sheet, documentation, the following safety instructions). Using the product requires technical skills and, in some cases, a basic knowledge of English. It is therefore essential that only skilled and specialized staff or thoroughly trained personnel with the required skills be allowed to use the product. If personal safety gear is required for using Rohde & Schwarz products, this will be indicated at the appropriate place in the product documentation. Keep the basic safety instructions and the product documentation in a safe place and pass them on to the subsequent users.











Observing the safety instructions will help prevent personal injury or damage of any kind caused by dangerous situations. Therefore, carefully read through and adhere to the following safety instructions before and when using the product. It is also absolutely essential to observe the additional safety instructions on personal safety, for example, that appear in relevant parts of the product documentation. In these safety instructions, the word "product" refers to all merchandise sold and distributed by the Rohde & Schwarz group of companies, including instruments, systems and all accessories. For product-specific information, see the data sheet and the product documentation.

## Safety labels on products

The following safety labels are used on products to warn against risks and dangers.

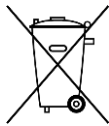
Symbol	Meaning	Symbol	Meaning
	Notice, general danger location Observe product documentation		ON/OFF Power
	Caution when handling heavy equipment		Standby indication
	Danger of electric shock		Direct current (DC)

## Basic Safety Instructions

Symbol	Meaning	Symbol	Meaning
	Caution ! Hot surface		Alternating current (AC)
	Protective conductor terminal To identify any terminal which is intended for connection to an external conductor for protection against electric shock in case of a fault, or the terminal of a protective earth		Direct/alternating current (DC/AC)
	Earth (Ground)		Class II Equipment to identify equipment meeting the safety requirements specified for Class II equipment (device protected by double or reinforced insulation)
	Frame or chassis Ground terminal		EU labeling for batteries and accumulators For additional information, see section "Waste disposal/Environmental protection", item 1.
	Be careful when handling electrostatic sensitive devices		EU labeling for separate collection of electrical and electronic devices For additional information, see section "Waste disposal/Environmental protection", item 2.
	Warning! Laser radiation For additional information, see section "Operation", item 7.		

### Signal words and their meaning

The following signal words are used in the product documentation in order to warn the reader about risks and dangers.



Indicates a hazardous situation which, if not avoided, will result in death or serious injury.



Indicates a hazardous situation which, if not avoided, could result in death or serious injury.



Indicates a hazardous situation which, if not avoided, could result in minor or moderate injury.



Indicates information considered important, but not hazard-related, e.g. messages relating to property damage.

In the product documentation, the word ATTENTION is used synonymously.

These signal words are in accordance with the standard definition for civil applications in the European Economic Area. Definitions that deviate from the standard definition may also exist in other economic areas or military applications. It is therefore essential to make sure that the signal words described here are always used only in connection with the related product documentation and the related product. The use of signal words in connection with unrelated products or documentation can result in misinterpretation and in personal injury or material damage.

## Basic Safety Instructions

### Operating states and operating positions

*The product may be operated only under the operating conditions and in the positions specified by the manufacturer, without the product's ventilation being obstructed. If the manufacturer's specifications are not observed, this can result in electric shock, fire and/or serious personal injury or death. Applicable local or national safety regulations and rules for the prevention of accidents must be observed in all work performed.*

1. Unless otherwise specified, the following requirements apply to Rohde & Schwarz products: predefined operating position is always with the housing floor facing down, IP protection 2X, use only indoors, max. operating altitude 2000 m above sea level, max. transport altitude 4500 m above sea level. A tolerance of  $\pm 10\%$  shall apply to the nominal voltage and  $\pm 5\%$  to the nominal frequency, overvoltage category 2, pollution degree 2.
2. Do not place the product on surfaces, vehicles, cabinets or tables that for reasons of weight or stability are unsuitable for this purpose. Always follow the manufacturer's installation instructions when installing the product and fastening it to objects or structures (e.g. walls and shelves). An installation that is not carried out as described in the product documentation could result in personal injury or even death.
3. Do not place the product on heat-generating devices such as radiators or fan heaters. The ambient temperature must not exceed the maximum temperature specified in the product documentation or in the data sheet. Product overheating can cause electric shock, fire and/or serious personal injury or even death.

### Electrical safety

*If the information on electrical safety is not observed either at all or to the extent necessary, electric shock, fire and/or serious personal injury or death may occur.*

1. Prior to switching on the product, always ensure that the nominal voltage setting on the product matches the nominal voltage of the mains-supply network. If a different voltage is to be set, the power fuse of the product may have to be changed accordingly.
2. In the case of products of safety class I with movable power cord and connector, operation is permitted only on sockets with a protective conductor contact and protective conductor.
3. Intentionally breaking the protective conductor either in the feed line or in the product itself is not permitted. Doing so can result in the danger of an electric shock from the product. If extension cords or connector strips are implemented, they must be checked on a regular basis to ensure that they are safe to use.
4. If there is no power switch for disconnecting the product from the mains, or if the power switch is not suitable for this purpose, use the plug of the connecting cable to disconnect the product from the mains. In such cases, always ensure that the power plug is easily reachable and accessible at all times. For example, if the power plug is the disconnecting device, the length of the connecting cable must not exceed 3 m. Functional or electronic switches are not suitable for providing disconnection from the AC supply network. If products without power switches are integrated into racks or systems, the disconnecting device must be provided at the system level.
5. Never use the product if the power cable is damaged. Check the power cables on a regular basis to ensure that they are in proper operating condition. By taking appropriate safety measures and carefully laying the power cable, ensure that the cable cannot be damaged and that no one can be hurt by, for example, tripping over the cable or suffering an electric shock.

## Basic Safety Instructions

6. The product may be operated only from TN/TT supply networks fuse-protected with max. 16 A (higher fuse only after consulting with the Rohde & Schwarz group of companies).
7. Do not insert the plug into sockets that are dusty or dirty. Insert the plug firmly and all the way into the socket provided for this purpose. Otherwise, sparks that result in fire and/or injuries may occur.
8. Do not overload any sockets, extension cords or connector strips; doing so can cause fire or electric shocks.
9. For measurements in circuits with voltages  $V_{rms} > 30$  V, suitable measures (e.g. appropriate measuring equipment, fuse protection, current limiting, electrical separation, insulation) should be taken to avoid any hazards.
10. Ensure that the connections with information technology equipment, e.g. PCs or other industrial computers, comply with the IEC 60950-1 / EN 60950-1 or IEC 61010-1 / EN 61010-1 standards that apply in each case.
11. Unless expressly permitted, never remove the cover or any part of the housing while the product is in operation. Doing so will expose circuits and components and can lead to injuries, fire or damage to the product.
12. If a product is to be permanently installed, the connection between the protective conductor terminal on site and the product's protective conductor must be made first before any other connection is made. The product may be installed and connected only by a licensed electrician.
13. For permanently installed equipment without built-in fuses, circuit breakers or similar protective devices, the supply circuit must be fuse-protected in such a way that anyone who has access to the product, as well as the product itself, is adequately protected from injury or damage.
14. Use suitable overvoltage protection to ensure that no overvoltage (such as that caused by a bolt of lightning) can reach the product. Otherwise, the person operating the product will be exposed to the danger of an electric shock.
15. Any object that is not designed to be placed in the openings of the housing must not be used for this purpose. Doing so can cause short circuits inside the product and/or electric shocks, fire or injuries.
16. Unless specified otherwise, products are not liquid-proof (see also section "Operating states and operating positions", item 1). Therefore, the equipment must be protected against penetration by liquids. If the necessary precautions are not taken, the user may suffer electric shock or the product itself may be damaged, which can also lead to personal injury.
17. Never use the product under conditions in which condensation has formed or can form in or on the product, e.g. if the product has been moved from a cold to a warm environment. Penetration by water increases the risk of electric shock.
18. Prior to cleaning the product, disconnect it completely from the power supply (e.g. AC supply network or battery). Use a soft, non-linting cloth to clean the product. Never use chemical cleaning agents such as alcohol, acetone or diluents for cellulose lacquers.

## Operation

1. Operating the products requires special training and intense concentration. Make sure that persons who use the products are physically, mentally and emotionally fit enough to do so; otherwise, injuries or material damage may occur. It is the responsibility of the employer/operator to select suitable personnel for operating the products.

## Basic Safety Instructions

2. Before you move or transport the product, read and observe the section titled "Transport".
3. As with all industrially manufactured goods, the use of substances that induce an allergic reaction (allergens) such as nickel cannot be generally excluded. If you develop an allergic reaction (such as a skin rash, frequent sneezing, red eyes or respiratory difficulties) when using a Rohde & Schwarz product, consult a physician immediately to determine the cause and to prevent health problems or stress.
4. Before you start processing the product mechanically and/or thermally, or before you take it apart, be sure to read and pay special attention to the section titled "Waste disposal/Environmental protection", item 1.
5. Depending on the function, certain products such as RF radio equipment can produce an elevated level of electromagnetic radiation. Considering that unborn babies require increased protection, pregnant women must be protected by appropriate measures. Persons with pacemakers may also be exposed to risks from electromagnetic radiation. The employer/operator must evaluate workplaces where there is a special risk of exposure to radiation and, if necessary, take measures to avert the potential danger.
6. Should a fire occur, the product may release hazardous substances (gases, fluids, etc.) that can cause health problems. Therefore, suitable measures must be taken, e.g. protective masks and protective clothing must be worn.
7. Laser products are given warning labels that are standardized according to their laser class. Lasers can cause biological harm due to the properties of their radiation and due to their extremely concentrated electromagnetic power. If a laser product (e.g. a CD/DVD drive) is integrated into a Rohde & Schwarz product, absolutely no other settings or functions may be used as described in the product documentation. The objective is to prevent personal injury (e.g. due to laser beams).
8. EMC classes (in line with EN 55011/CISPR 11, and analogously with EN 55022/CISPR 22, EN 55032/CISPR 32)
  - Class A equipment:  
Equipment suitable for use in all environments except residential environments and environments that are directly connected to a low-voltage supply network that supplies residential buildings  
Note: Class A equipment is intended for use in an industrial environment. This equipment may cause radio disturbances in residential environments, due to possible conducted as well as radiated disturbances. In this case, the operator may be required to take appropriate measures to eliminate these disturbances.
  - Class B equipment:  
Equipment suitable for use in residential environments and environments that are directly connected to a low-voltage supply network that supplies residential buildings

### Repair and service

1. The product may be opened only by authorized, specially trained personnel. Before any work is performed on the product or before the product is opened, it must be disconnected from the AC supply network. Otherwise, personnel will be exposed to the risk of an electric shock.

## Basic Safety Instructions

- Adjustments, replacement of parts, maintenance and repair may be performed only by electrical experts authorized by Rohde & Schwarz. Only original parts may be used for replacing parts relevant to safety (e.g. power switches, power transformers, fuses). A safety test must always be performed after parts relevant to safety have been replaced (visual inspection, protective conductor test, insulation resistance measurement, leakage current measurement, functional test). This helps ensure the continued safety of the product.

### Batteries and rechargeable batteries/cells

*If the information regarding batteries and rechargeable batteries/cells is not observed either at all or to the extent necessary, product users may be exposed to the risk of explosions, fire and/or serious personal injury, and, in some cases, death. Batteries and rechargeable batteries with alkaline electrolytes (e.g. lithium cells) must be handled in accordance with the EN 62133 standard.*

- Cells must not be taken apart or crushed.
- Cells or batteries must not be exposed to heat or fire. Storage in direct sunlight must be avoided. Keep cells and batteries clean and dry. Clean soiled connectors using a dry, clean cloth.
- Cells or batteries must not be short-circuited. Cells or batteries must not be stored in a box or in a drawer where they can short-circuit each other, or where they can be short-circuited by other conductive materials. Cells and batteries must not be removed from their original packaging until they are ready to be used.
- Cells and batteries must not be exposed to any mechanical shocks that are stronger than permitted.
- If a cell develops a leak, the fluid must not be allowed to come into contact with the skin or eyes. If contact occurs, wash the affected area with plenty of water and seek medical aid.
- Improperly replacing or charging cells or batteries that contain alkaline electrolytes (e.g. lithium cells) can cause explosions. Replace cells or batteries only with the matching Rohde & Schwarz type (see parts list) in order to ensure the safety of the product.
- Cells and batteries must be recycled and kept separate from residual waste. Rechargeable batteries and normal batteries that contain lead, mercury or cadmium are hazardous waste. Observe the national regulations regarding waste disposal and recycling.
- Follow the transport stipulations of the carrier (IATA-DGR, IMDG-Code, ADR, RID) when returning lithium batteries to Rohde & Schwarz subsidiaries.

### Transport

- The product may be very heavy. Therefore, the product must be handled with care. In some cases, the user may require a suitable means of lifting or moving the product (e.g. with a lift-truck) to avoid back or other physical injuries.
- Handles on the products are designed exclusively to enable personnel to transport the product. It is therefore not permissible to use handles to fasten the product to or on transport equipment such as cranes, fork lifts, wagons, etc. The user is responsible for securely fastening the products to or on the means of transport or lifting. Observe the safety regulations of the manufacturer of the means of transport or lifting. Noncompliance can result in personal injury or material damage.

## Instrucciones de seguridad elementales

3. If you use the product in a vehicle, it is the sole responsibility of the driver to drive the vehicle safely and properly. The manufacturer assumes no responsibility for accidents or collisions. Never use the product in a moving vehicle if doing so could distract the driver of the vehicle. Adequately secure the product in the vehicle to prevent injuries or other damage in the event of an accident.

### Waste disposal/Environmental protection

1. Specially marked equipment has a battery or accumulator that must not be disposed of with unsorted municipal waste, but must be collected separately. It may only be disposed of at a suitable collection point or via a Rohde & Schwarz customer service center.
2. Waste electrical and electronic equipment must not be disposed of with unsorted municipal waste, but must be collected separately.  
Rohde & Schwarz GmbH & Co. KG has developed a disposal concept and takes full responsibility for take-back obligations and disposal obligations for manufacturers within the EU. Contact your Rohde & Schwarz customer service center for environmentally responsible disposal of the product.
3. If products or their components are mechanically and/or thermally processed in a manner that goes beyond their intended use, hazardous substances (heavy-metal dust such as lead, beryllium, nickel) may be released. For this reason, the product may only be disassembled by specially trained personnel. Improper disassembly may be hazardous to your health. National waste disposal regulations must be observed.
4. If handling the product releases hazardous substances or fuels that must be disposed of in a special way, e.g. coolants or engine oils that must be replenished regularly, the safety instructions of the manufacturer of the hazardous substances or fuels and the applicable regional waste disposal regulations must be observed. Also observe the relevant safety instructions in the product documentation. The improper disposal of hazardous substances or fuels can cause health problems and lead to environmental damage.

For additional information about environmental protection, visit the Rohde & Schwarz website.

# Instrucciones de seguridad elementales

### ¡Es imprescindible leer y cumplir las siguientes instrucciones e informaciones de seguridad!

El principio del grupo de empresas Rohde & Schwarz consiste en tener nuestros productos siempre al día con los estándares de seguridad y de ofrecer a nuestros clientes el máximo grado de seguridad. Nuestros productos y todos los equipos adicionales son siempre fabricados y examinados según las normas de seguridad vigentes. Nuestro sistema de garantía de calidad controla constantemente que sean cumplidas estas normas. El presente producto ha sido fabricado y examinado según el certificado de conformidad de la UE y ha salido de nuestra planta en estado impecable según los estándares técnicos de seguridad. Para poder preservar este estado y garantizar un funcionamiento libre de peligros, el usuario deberá atenerse a todas las indicaciones, informaciones de seguridad y notas de alerta. El grupo de empresas Rohde & Schwarz está siempre a su disposición en caso de que tengan preguntas referentes a estas informaciones de seguridad.



## Instrucciones de seguridad elementales











Además queda en la responsabilidad del usuario utilizar el producto en la forma debida. Este producto está destinado exclusivamente al uso en la industria y el laboratorio o, si ha sido expresamente autorizado, para aplicaciones de campo y de ninguna manera deberá ser utilizado de modo que alguna persona/cosa pueda sufrir daño. El uso del producto fuera de sus fines definidos o sin tener en cuenta las instrucciones del fabricante queda en la responsabilidad del usuario. El fabricante no se hace en ninguna forma responsable de consecuencias a causa del mal uso del producto.

Se parte del uso correcto del producto para los fines definidos si el producto es utilizado conforme a las indicaciones de la correspondiente documentación del producto y dentro del margen de rendimiento definido (ver hoja de datos, documentación, informaciones de seguridad que siguen). El uso del producto hace necesarios conocimientos técnicos y ciertos conocimientos del idioma inglés. Por eso se debe tener en cuenta que el producto solo pueda ser operado por personal especializado o personas instruidas en profundidad con las capacidades correspondientes. Si fuera necesaria indumentaria de seguridad para el uso de productos de Rohde & Schwarz, encontraría la información debida en la documentación del producto en el capítulo correspondiente. Guarde bien las informaciones de seguridad elementales, así como la documentación del producto, y entréguelas a usuarios posteriores.







Tener en cuenta las informaciones de seguridad sirve para evitar en lo posible lesiones o daños por peligros de toda clase. Por eso es imprescindible leer detalladamente y comprender por completo las siguientes informaciones de seguridad antes de usar el producto, y respetarlas durante el uso del producto. Deberán tenerse en cuenta todas las demás informaciones de seguridad, como p. ej. las referentes a la protección de personas, que encontrarán en el capítulo correspondiente de la documentación del producto y que también son de obligado cumplimiento. En las presentes informaciones de seguridad se recogen todos los objetos que distribuye el grupo de empresas Rohde & Schwarz bajo la denominación de "producto", entre ellos también aparatos, instalaciones así como toda clase de accesorios. Los datos específicos del producto figuran en la hoja de datos y en la documentación del producto.

### Señalización de seguridad de los productos

Las siguientes señales de seguridad se utilizan en los productos para advertir sobre riesgos y peligros.

Símbolo	Significado	Símbolo	Significado
	Aviso: punto de peligro general Observar la documentación del producto		Tensión de alimentación de PUESTA EN MARCHA / PARADA
	Atención en el manejo de dispositivos de peso elevado		Indicación de estado de espera (standby)
	Peligro de choque eléctrico		Corriente continua (DC)
	Advertencia: superficie caliente		Corriente alterna (AC)
	Conexión a conductor de protección		Corriente continua / Corriente alterna (DC/AC)

## Instrucciones de seguridad elementales

Símbolo	Significado	Símbolo	Significado
	Conexión a tierra		El aparato está protegido en su totalidad por un aislamiento doble (reforzado)
	Conexión a masa		Distintivo de la UE para baterías y acumuladores Más información en la sección "Eliminación/protección del medio ambiente", punto 1.
	Aviso: Cuidado en el manejo de dispositivos sensibles a la electrostática (ESD)		Distintivo de la UE para la eliminación por separado de dispositivos eléctricos y electrónicos Más información en la sección "Eliminación/protección del medio ambiente", punto 2.
	Advertencia: rayo láser Más información en la sección "Funcionamiento", punto 7.		

### Palabras de señal y su significado

En la documentación del producto se utilizan las siguientes palabras de señal con el fin de advertir contra riesgos y peligros.



Indica una situación de peligro que, si no se evita, causa lesiones graves o incluso la muerte.



Indica una situación de peligro que, si no se evita, puede causar lesiones graves o incluso la muerte.



Indica una situación de peligro que, si no se evita, puede causar lesiones leves o moderadas.



Indica información que se considera importante, pero no en relación con situaciones de peligro; p. ej., avisos sobre posibles daños materiales.

En la documentación del producto se emplea de forma sinónima el término CUIDADO.

Las palabras de señal corresponden a la definición habitual para aplicaciones civiles en el área económica europea. Pueden existir definiciones diferentes a esta definición en otras áreas económicas o en aplicaciones militares. Por eso se deberá tener en cuenta que las palabras de señal aquí descritas sean utilizadas siempre solamente en combinación con la correspondiente documentación del producto y solamente en combinación con el producto correspondiente. La utilización de las palabras de señal en combinación con productos o documentaciones que no les correspondan puede llevar a interpretaciones equivocadas y tener por consecuencia daños en personas u objetos.

## Instrucciones de seguridad elementales

### Estados operativos y posiciones de funcionamiento

*El producto solamente debe ser utilizado según lo indicado por el fabricante respecto a los estados operativos y posiciones de funcionamiento sin que se obstruya la ventilación. Si no se siguen las indicaciones del fabricante, pueden producirse choques eléctricos, incendios y/o lesiones graves con posible consecuencia de muerte. En todos los trabajos deberán ser tenidas en cuenta las normas nacionales y locales de seguridad del trabajo y de prevención de accidentes.*

1. Si no se convino de otra manera, es para los productos Rohde & Schwarz válido lo que sigue: como posición de funcionamiento se define por principio la posición con el suelo de la caja para abajo, modo de protección IP 2X, uso solamente en estancias interiores, utilización hasta 2000 m sobre el nivel del mar, transporte hasta 4500 m sobre el nivel del mar. Se aplicará una tolerancia de  $\pm 10\%$  sobre el voltaje nominal y de  $\pm 5\%$  sobre la frecuencia nominal. Categoría de sobrecarga eléctrica 2, índice de suciedad 2.
2. No sitúe el producto encima de superficies, vehículos, estantes o mesas, que por sus características de peso o de estabilidad no sean aptos para él. Siga siempre las instrucciones de instalación del fabricante cuando instale y asegure el producto en objetos o estructuras (p. ej. paredes y estantes). Si se realiza la instalación de modo distinto al indicado en la documentación del producto, se pueden causar lesiones o, en determinadas circunstancias, incluso la muerte.
3. No ponga el producto sobre aparatos que generen calor (p. ej. radiadores o calefactores). La temperatura ambiente no debe superar la temperatura máxima especificada en la documentación del producto o en la hoja de datos. En caso de sobrecalentamiento del producto, pueden producirse choques eléctricos, incendios y/o lesiones graves con posible consecuencia de muerte.

### Seguridad eléctrica

*Si no se siguen (o se siguen de modo insuficiente) las indicaciones del fabricante en cuanto a seguridad eléctrica, pueden producirse choques eléctricos, incendios y/o lesiones graves con posible consecuencia de muerte.*

1. Antes de la puesta en marcha del producto se deberá comprobar siempre que la tensión preseleccionada en el producto coincida con la de la red de alimentación eléctrica. Si es necesario modificar el ajuste de tensión, también se deberán cambiar en caso dado los fusibles correspondientes del producto.
2. Los productos de la clase de protección I con alimentación móvil y enchufe individual solamente podrán enchufarse a tomas de corriente con contacto de seguridad y con conductor de protección conectado.
3. Queda prohibida la interrupción intencionada del conductor de protección, tanto en la toma de corriente como en el mismo producto. La interrupción puede tener como consecuencia el riesgo de que el producto sea fuente de choques eléctricos. Si se utilizan cables alargadores o regletas de enchufe, deberá garantizarse la realización de un examen regular de los mismos en cuanto a su estado técnico de seguridad.
4. Si el producto no está equipado con un interruptor para desconectarlo de la red, o bien si el interruptor existente no resulta apropiado para la desconexión de la red, el enchufe del cable de conexión se deberá considerar como un dispositivo de desconexión. El dispositivo de desconexión se debe poder alcanzar fácilmente y debe estar siempre bien accesible. Si, p. ej., el enchufe de conexión a la red es el dispositivo de desconexión, la longitud del cable de conexión no debe superar 3 m).  
Los interruptores selectores o electrónicos no son aptos para el corte de la red eléctrica. Si se

## Instrucciones de seguridad elementales

integran productos sin interruptor en bastidores o instalaciones, se deberá colocar el interruptor en el nivel de la instalación.

5. No utilice nunca el producto si está dañado el cable de conexión a red. Compruebe regularmente el correcto estado de los cables de conexión a red. Asegúrese, mediante las medidas de protección y de instalación adecuadas, de que el cable de conexión a red no pueda ser dañado o de que nadie pueda ser dañado por él, p. ej. al tropezar o por un choque eléctrico.
6. Solamente está permitido el funcionamiento en redes de alimentación TN/TT aseguradas con fusibles de 16 A como máximo (utilización de fusibles de mayor amperaje solo previa consulta con el grupo de empresas Rohde & Schwarz).
7. Nunca conecte el enchufe en tomas de corriente sucias o llenas de polvo. Introduzca el enchufe por completo y fuertemente en la toma de corriente. La no observación de estas medidas puede provocar chispas, fuego y/o lesiones.
8. No sobrecargue las tomas de corriente, los cables alargadores o las regletas de enchufe ya que esto podría causar fuego o choques eléctricos.
9. En las mediciones en circuitos de corriente con una tensión  $U_{\text{eff}} > 30 \text{ V}$  se deberán tomar las medidas apropiadas para impedir cualquier peligro (p. ej. medios de medición adecuados, seguros, limitación de tensión, corte protector, aislamiento etc.).
10. Para la conexión con dispositivos informáticos como un PC o un ordenador industrial, debe comprobarse que éstos cumplan los estándares IEC60950-1/EN60950-1 o IEC61010-1/EN 61010-1 válidos en cada caso.
11. A menos que esté permitido expresamente, no retire nunca la tapa ni componentes de la carcasa mientras el producto esté en servicio. Esto pone a descubierto los cables y componentes eléctricos y puede causar lesiones, fuego o daños en el producto.
12. Si un producto se instala en un lugar fijo, se deberá primero conectar el conductor de protección fijo con el conductor de protección del producto antes de hacer cualquier otra conexión. La instalación y la conexión deberán ser efectuadas por un electricista especializado.
13. En el caso de dispositivos fijos que no estén provistos de fusibles, interruptor automático ni otros mecanismos de seguridad similares, el circuito de alimentación debe estar protegido de modo que todas las personas que puedan acceder al producto, así como el producto mismo, estén a salvo de posibles daños.
14. Todo producto debe estar protegido contra sobretensión (debida p. ej. a una caída del rayo) mediante los correspondientes sistemas de protección. Si no, el personal que lo utilice quedará expuesto al peligro de choque eléctrico.
15. No debe introducirse en los orificios de la caja del aparato ningún objeto que no esté destinado a ello. Esto puede producir cortocircuitos en el producto y/o puede causar choques eléctricos, fuego o lesiones.
16. Salvo indicación contraria, los productos no están impermeabilizados (ver también el capítulo "Estados operativos y posiciones de funcionamiento", punto 1). Por eso es necesario tomar las medidas necesarias para evitar la entrada de líquidos. En caso contrario, existe peligro de choque eléctrico para el usuario o de daños en el producto, que también pueden redundar en peligro para las personas.

## Instrucciones de seguridad elementales

17. No utilice el producto en condiciones en las que pueda producirse o ya se hayan producido condensaciones sobre el producto o en el interior de éste, como p. ej. al desplazarlo de un lugar frío a otro caliente. La entrada de agua aumenta el riesgo de choque eléctrico.
18. Antes de la limpieza, desconecte por completo el producto de la alimentación de tensión (p. ej. red de alimentación o batería). Realice la limpieza de los aparatos con un paño suave, que no se deshilache. No utilice bajo ningún concepto productos de limpieza químicos como alcohol, acetona o diluyentes para lacas nitrocelulósicas.

### Funcionamiento

1. El uso del producto requiere instrucciones especiales y una alta concentración durante el manejo. Debe asegurarse que las personas que manejen el producto estén a la altura de los requerimientos necesarios en cuanto a aptitudes físicas, psíquicas y emocionales, ya que de otra manera no se pueden excluir lesiones o daños de objetos. El empresario u operador es responsable de seleccionar el personal usuario apto para el manejo del producto.
2. Antes de desplazar o transportar el producto, lea y tenga en cuenta el capítulo "Transporte".
3. Como con todo producto de fabricación industrial no puede quedar excluida en general la posibilidad de que se produzcan alergias provocadas por algunos materiales empleados —los llamados alérgenos (p. ej. el níquel)—. Si durante el manejo de productos Rohde & Schwarz se producen reacciones alérgicas, como p. ej. irritaciones cutáneas, estornudos continuos, enrojecimiento de la conjuntiva o dificultades respiratorias, debe avisarse inmediatamente a un médico para investigar las causas y evitar cualquier molestia o daño a la salud.
4. Antes de la manipulación mecánica y/o térmica o el desmontaje del producto, debe tenerse en cuenta imprescindiblemente el capítulo "Eliminación/protección del medio ambiente", punto 1.
5. Ciertos productos, como p. ej. las instalaciones de radiocomunicación RF, pueden a causa de su función natural, emitir una radiación electromagnética aumentada. Deben tomarse todas las medidas necesarias para la protección de las mujeres embarazadas. También las personas con marcapasos pueden correr peligro a causa de la radiación electromagnética. El empresario/operador tiene la obligación de evaluar y señalar las áreas de trabajo en las que exista un riesgo elevado de exposición a radiaciones.
6. Tenga en cuenta que en caso de incendio pueden desprenderse del producto sustancias tóxicas (gases, líquidos etc.) que pueden generar daños a la salud. Por eso, en caso de incendio deben usarse medidas adecuadas, como p. ej. máscaras antigás e indumentaria de protección.
7. Los productos con láser están provistos de indicaciones de advertencia normalizadas en función de la clase de láser del que se trate. Los rayos láser pueden provocar daños de tipo biológico a causa de las propiedades de su radiación y debido a su concentración extrema de potencia electromagnética. En caso de que un producto Rohde & Schwarz contenga un producto láser (p. ej. un lector de CD/DVD), no debe usarse ninguna otra configuración o función aparte de las descritas en la documentación del producto, a fin de evitar lesiones (p. ej. debidas a irradiación láser).
8. Clases de compatibilidad electromagnética (conforme a EN 55011 / CISPR 11; y en analogía con EN 55022 / CISPR 22, EN 55032 / CISPR 32)
  - Aparato de clase A:  
Aparato adecuado para su uso en todos los entornos excepto en los residenciales y en aquellos conectados directamente a una red de distribución de baja tensión que suministra corriente a edificios residenciales.  
Nota: Los aparatos de clase A están destinados al uso en entornos industriales. Estos aparatos

## Instrucciones de seguridad elementales

pueden causar perturbaciones radioeléctricas en entornos residenciales debido a posibles perturbaciones guiadas o radiadas. En este caso, se le podrá solicitar al operador que tome las medidas adecuadas para eliminar estas perturbaciones.

- Aparato de clase B:  
Aparato adecuado para su uso en entornos residenciales, así como en aquellos conectados directamente a una red de distribución de baja tensión que suministra corriente a edificios residenciales.

### Reparación y mantenimiento

1. El producto solamente debe ser abierto por personal especializado con autorización para ello. Antes de manipular el producto o abrirlo, es obligatorio desconectarlo de la tensión de alimentación, para evitar toda posibilidad de choque eléctrico.
2. El ajuste, el cambio de partes, el mantenimiento y la reparación deberán ser efectuadas solamente por electricistas autorizados por Rohde & Schwarz. Si se reponen partes con importancia para los aspectos de seguridad (p. ej. el enchufe, los transformadores o los fusibles), solamente podrán ser sustituidos por partes originales. Después de cada cambio de partes relevantes para la seguridad deberá realizarse un control de seguridad (control a primera vista, control del conductor de protección, medición de resistencia de aislamiento, medición de la corriente de fuga, control de funcionamiento). Con esto queda garantizada la seguridad del producto.

### Baterías y acumuladores o celdas

*Si no se siguen (o se siguen de modo insuficiente) las indicaciones en cuanto a las baterías y acumuladores o celdas, pueden producirse explosiones, incendios y/o lesiones graves con posible consecuencia de muerte. El manejo de baterías y acumuladores con electrolitos alcalinos (p. ej. celdas de litio) debe seguir el estándar EN 62133.*

1. No deben desmontarse, abrirse ni triturarse las celdas.
2. Las celdas o baterías no deben someterse a calor ni fuego. Debe evitarse el almacenamiento a la luz directa del sol. Las celdas y baterías deben mantenerse limpias y secas. Limpiar las conexiones sucias con un paño seco y limpio.
3. Las celdas o baterías no deben cortocircuitarse. Es peligroso almacenar las celdas o baterías en estuches o cajones en cuyo interior puedan cortocircuitarse por contacto recíproco o por contacto con otros materiales conductores. No deben extraerse las celdas o baterías de sus embalajes originales hasta el momento en que vayan a utilizarse.
4. Las celdas o baterías no deben someterse a impactos mecánicos fuertes indebidos.
5. En caso de falta de estanqueidad de una celda, el líquido vertido no debe entrar en contacto con la piel ni los ojos. Si se produce contacto, lavar con agua abundante la zona afectada y avisar a un médico.
6. En caso de cambio o recarga inadecuados, las celdas o baterías que contienen electrolitos alcalinos (p. ej. las celdas de litio) pueden explotar. Para garantizar la seguridad del producto, las celdas o baterías solo deben ser sustituidas por el tipo Rohde & Schwarz correspondiente (ver lista de recambios).
7. Las baterías y celdas deben reciclarse y no deben tirarse a la basura doméstica. Las baterías o acumuladores que contienen plomo, mercurio o cadmio deben tratarse como residuos especiales. Respete en esta relación las normas nacionales de eliminación y reciclaje.

## Instrucciones de seguridad elementales

8. En caso de devolver baterías de litio a las filiales de Rohde & Schwarz, debe cumplirse las normativas sobre los modos de transporte (IATA-DGR, código IMDG, ADR, RID).

### Transporte

1. El producto puede tener un peso elevado. Por eso es necesario desplazarlo o transportarlo con precaución y, si es necesario, usando un sistema de elevación adecuado (p. ej. una carretilla elevadora), a fin de evitar lesiones en la espalda u otros daños personales.
2. Las asas instaladas en los productos sirven solamente de ayuda para el transporte del producto por personas. Por eso no está permitido utilizar las asas para la sujeción en o sobre medios de transporte como p. ej. grúas, carretillas elevadoras de horquilla, carros etc. Es responsabilidad suya fijar los productos de manera segura a los medios de transporte o elevación. Para evitar daños personales o daños en el producto, siga las instrucciones de seguridad del fabricante del medio de transporte o elevación utilizado.
3. Si se utiliza el producto dentro de un vehículo, recae de manera exclusiva en el conductor la responsabilidad de conducir el vehículo de manera segura y adecuada. El fabricante no asumirá ninguna responsabilidad por accidentes o colisiones. No utilice nunca el producto dentro de un vehículo en movimiento si esto pudiera distraer al conductor. Asegure el producto dentro del vehículo debidamente para evitar, en caso de un accidente, lesiones u otra clase de daños.

### Eliminación/protección del medio ambiente

1. Los dispositivos marcados contienen una batería o un acumulador que no se debe desechar con los residuos domésticos sin clasificar, sino que debe ser recogido por separado. La eliminación se debe efectuar exclusivamente a través de un punto de recogida apropiado o del servicio de atención al cliente de Rohde & Schwarz.
2. Los dispositivos eléctricos usados no se deben desechar con los residuos domésticos sin clasificar, sino que deben ser recogidos por separado.  
Rohde & Schwarz GmbH & Co.KG ha elaborado un concepto de eliminación de residuos y asume plenamente los deberes de recogida y eliminación para los fabricantes dentro de la UE. Para desechar el producto de manera respetuosa con el medio ambiente, diríjase a su servicio de atención al cliente de Rohde & Schwarz.
3. Si se trabaja de manera mecánica y/o térmica cualquier producto o componente más allá del funcionamiento previsto, pueden liberarse sustancias peligrosas (polvos con contenido de metales pesados como p. ej. plomo, berilio o níquel). Por eso el producto solo debe ser desmontado por personal especializado con formación adecuada. Un desmontaje inadecuado puede ocasionar daños para la salud. Se deben tener en cuenta las directivas nacionales referentes a la eliminación de residuos.
4. En caso de que durante el trato del producto se formen sustancias peligrosas o combustibles que deban tratarse como residuos especiales (p. ej. refrigerantes o aceites de motor con intervalos de cambio definidos), deben tenerse en cuenta las indicaciones de seguridad del fabricante de dichas sustancias y las normas regionales de eliminación de residuos. Tenga en cuenta también en caso necesario las indicaciones de seguridad especiales contenidas en la documentación del producto. La eliminación incorrecta de sustancias peligrosas o combustibles puede causar daños a la salud o daños al medio ambiente.

Se puede encontrar más información sobre la protección del medio ambiente en la página web de Rohde & Schwarz.

## Safety Instructions for Instruments with Fold-Out Feet

### **⚠ WARNING**

#### **Danger of injury**

The feet may fold in if they are not folded out completely or if the instrument is shifted. The feet may break if they are overloaded.

Fold the feet completely in or completely out to ensure stability of the instrument and personal safety.

To avoid injuries, never shift the instrument when its feet are folded out.

The overall load (the instrument's own weight plus that of the instruments stacked on top of it) on the folded-out feet must not exceed 500 N.

Place the instrument on a stable surface. Secure the instruments stacked on top of it against slipping (e.g. by locking their feet on the top front frame).

When the instrument is standing on its folded-out feet, do not work under the instrument and do not put anything under it, otherwise injuries or material damage could occur.

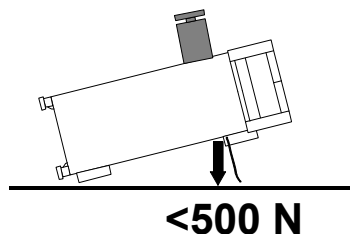

The instrument can be used in each of the positions shown here.

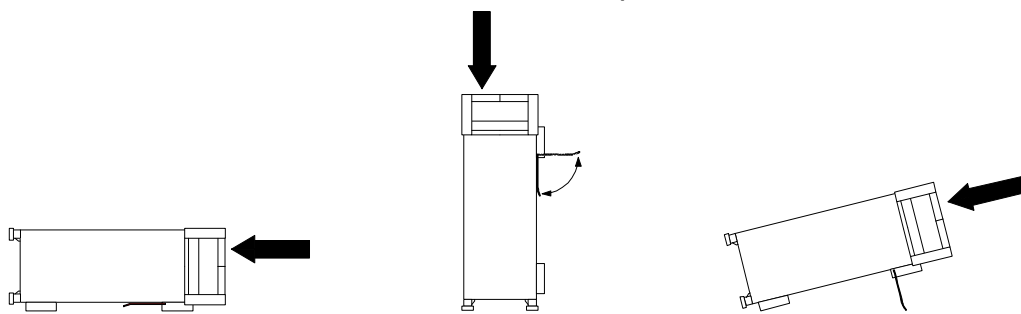



## Informaciones de seguridad para aparatos con telepiés

### **⚠ ADVERTENCIA**

#### **Peligro de heridas**

Los telepiés pueden doblarse hacia adentro si no han sido desdoblados por completo o si el aparato es movido. Los telepiés pueden romperse si son sobrecargados.

Doblar los telepiés por completo hacia afuera o hacia adentro. De esta manera se puede asegurar la estabilidad del aparato y a la vez la seguridad de las personas.

No mover nunca el aparato con los telepiés desdoblados, para evitar heridas.

El peso total equilibrado (peso propio más el de los aparatos posicionados sobre este) ejercido sobre los telepiés no deberá exceder a los 500 N.

Posicionar el aparato sobre una superficie estable. Los aparatos puestos encima de éste deben estar asegurados para que no resbalen (por ejemplo fijando los pies del aparato en el listón del marco de delante arriba).

Por favor no manipulen debajo del aparato y no pongan nada debajo de este cuando esté posicionado sobre los telepiés desdoblados, ya que si no pueden originarse heridas o daños en objetos.

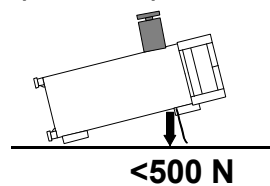

El aparato puede ser puesto en funcionamiento en cualquiera de las posiciones aquí descritas.

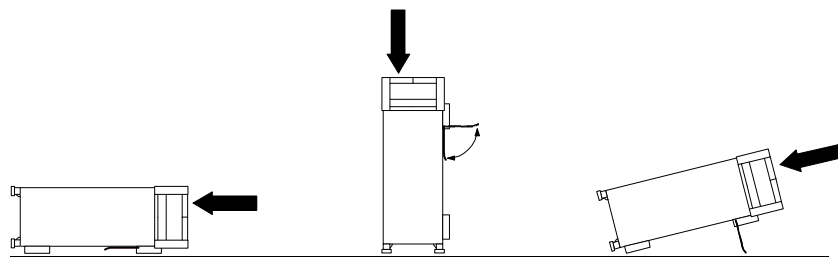

## Safety Instructions for Stacking Instruments

**⚠ WARNING**

### Danger of injury

Instruments may slip if they are stacked on top of each other.

Place the instrument on a stable, even surface. Stack the instruments according to their size, with the largest instrument on the bottom. Do not stack more than three instruments directly on top of each other. Instruments may only be stacked if their feet and housing allow horizontal stacking. If these conditions are not met, the instruments must be installed in a rack in order to avoid the risk of personal injury and material damage.

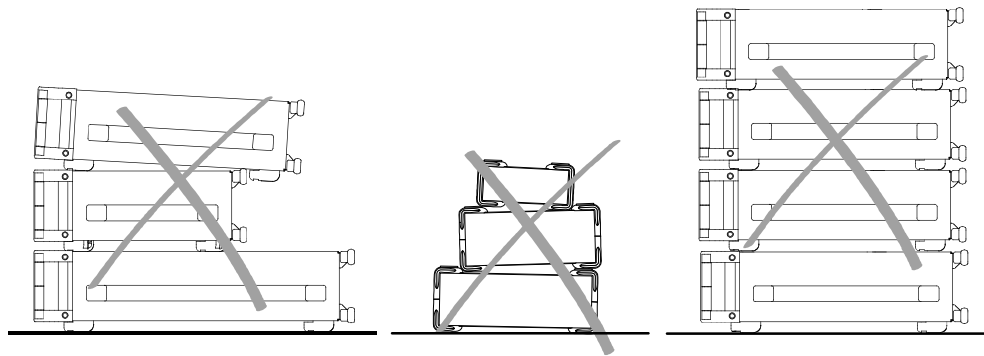
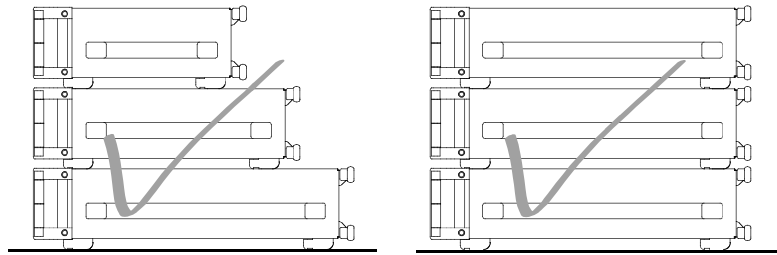

Incorrect order

Incompatible feet

Too many instruments stacked

## Informaciones de seguridad para el amontonamiento de aparatos

### **⚠ ADVERTENCIA**

#### **Peligro de heridas**

Los aparatos pueden desplazarse al ser amontonados.

Posicionar los aparatos sobre una superficie estable y lisa. Amontonar los aparatos por orden de su tamaño. No amontonar nunca más de tres aparatos uno sobre el otro. Los aparatos solamente deberán ser amontonados, si los piés y la caja del aparato correspondiente hacen posible amontonarlos de forma horizontal. Si no se cumplen estas condiciones, deberán ser montados los aparatos en una caja apta para este propósito. De esta manera evitarán el riesgo de daños en personas y daños en el aparato.

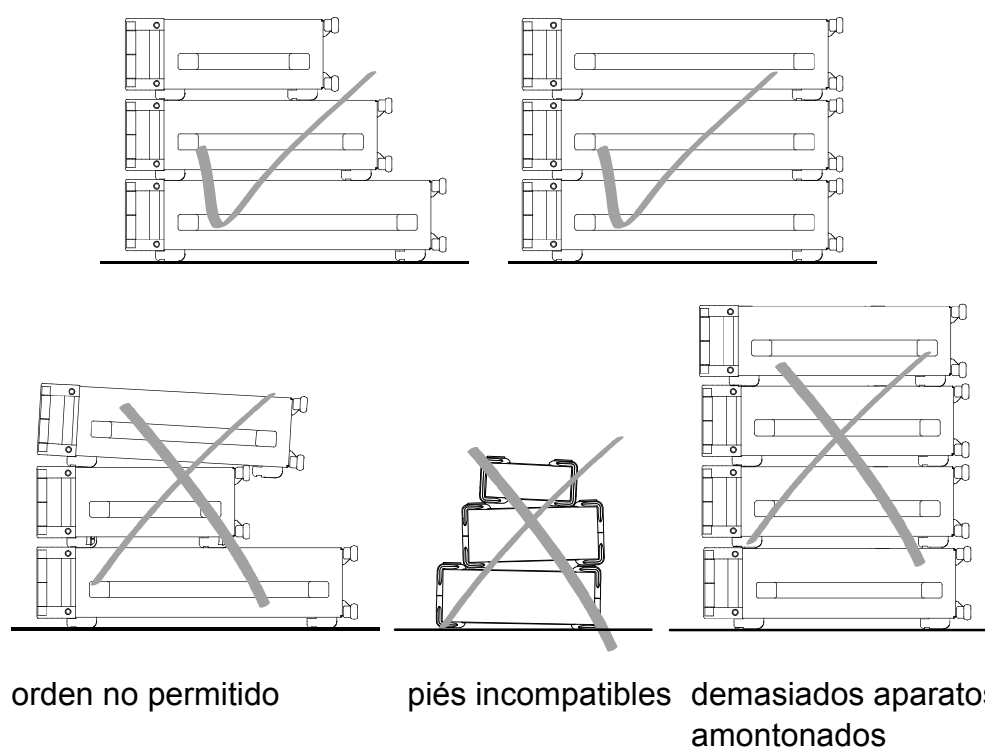

# Customer Support

## Technical support – where and when you need it

For quick, expert help with any Rohde & Schwarz equipment, contact one of our Customer Support Centers. A team of highly qualified engineers provides telephone support and will work with you to find a solution to your query on any aspect of the operation, programming or applications of Rohde & Schwarz equipment.

## Up-to-date information and upgrades

To keep your instrument up-to-date and to be informed about new application notes related to your instrument, please send an e-mail to the Customer Support Center stating your instrument and your wish. We will take care that you will get the right information.

### Europe, Africa, Middle East

Phone +49 89 4129 12345  
[customersupport@rohde-schwarz.com](mailto:customersupport@rohde-schwarz.com)

### North America

Phone 1-888-TEST-RSA (1-888-837-8772)  
[customer.support@rsa.rohde-schwarz.com](mailto:customer.support@rsa.rohde-schwarz.com)

### Latin America

Phone +1-410-910-7988  
[customersupport.la@rohde-schwarz.com](mailto:customersupport.la@rohde-schwarz.com)

### Asia/Pacific

Phone +65 65 13 04 88  
[customersupport.asia@rohde-schwarz.com](mailto:customersupport.asia@rohde-schwarz.com)

### China

Phone +86-800-810-8228 /  
+86-400-650-5896  
[customersupport.china@rohde-schwarz.com](mailto:customersupport.china@rohde-schwarz.com)



# Contents

<b>1</b>	<b>Preface</b> .....	<b>7</b>
1.1	For Your Safety.....	7
1.2	Conventions Used in the Documentation.....	7
<b>2</b>	<b>Documentation Overview</b> .....	<b>9</b>
2.1	Getting Started Manual.....	9
2.2	User Manuals and Help.....	9
2.3	Tutorials.....	9
2.4	Basic Safety Instructions.....	9
2.5	Data Sheets and Brochures.....	10
2.6	Release Notes and Open Source Acknowledgment (OSA).....	10
2.7	Application Notes, Application Cards, White Papers, etc.....	10
<b>3</b>	<b>System Overview</b> .....	<b>11</b>
3.1	Basic Instrument Concept.....	11
3.1.1	Baseband Section.....	12
3.1.2	RF Section.....	13
<b>4</b>	<b>Setting Up the R&amp;S SFE100</b> .....	<b>14</b>
4.1	Unpacking the R&S SFE100.....	14
4.1.1	Inspecting for Shipping Damage.....	14
4.1.2	Unpacking the Cardboard Box.....	14
4.1.3	Checking the Accessories.....	15
4.1.4	Warranty Conditions.....	15
4.2	Putting Up the R&S SFE100.....	15
4.2.1	Placing the R&S SFE100 on a Bench Top.....	15
4.2.2	Mounting the R&S SFE100 in a Rack.....	16
<b>5</b>	<b>Interfaces and Connectors</b> .....	<b>17</b>
5.1	Front Panel.....	17
5.1.1	Hardkeys.....	17
5.1.2	Status Display LEDs.....	18
5.1.3	Cursor Keys.....	19
5.1.4	Display.....	19

5.1.5	RF OUT.....	19
5.1.6	USB Interfaces.....	20
<b>5.2</b>	<b>Rear Panel.....</b>	<b>21</b>
5.2.1	AC Power Supply Connector and Switch.....	21
5.2.2	TS1 IN / TS2 IN.....	21
5.2.3	VIDEO IN.....	22
5.2.4	AUDIO AUX.....	22
5.2.5	MONITOR.....	23
5.2.6	100 BASE-T.....	23
5.2.7	DIG I/Q.....	24
5.2.8	USB Interface.....	26
5.2.9	REF IN.....	26
5.2.10	1PPS / TRIG.....	26
5.2.11	RF OUT.....	26
<b>6</b>	<b>Connecting the R&amp;S SFE100.....</b>	<b>28</b>
6.1	Preventing Electromagnetic Interference.....	28
6.2	Connecting to the AC Power Supply.....	28
6.3	Connecting External Devices.....	29
6.3.1	External Keyboard.....	30
6.3.2	Mouse.....	31
6.3.3	Memory Stick.....	31
6.3.4	External Monitor.....	31
<b>7</b>	<b>Switching On or Off the R&amp;S SFE100.....</b>	<b>33</b>
7.1	Switching On the R&S SFE100.....	33
7.2	Switching Off the R&S SFE100.....	34
7.3	Checking the Provided Options.....	34
7.4	Turn-On Tests.....	35
<b>8</b>	<b>Sample Application.....</b>	<b>36</b>
8.1	Using Display and Keys on the Front Panel.....	41
<b>9</b>	<b>Operating the R&amp;S SFE100 in a LAN.....</b>	<b>45</b>
9.1	Connecting the R&S SFE100 to the Network.....	45
9.2	Establishing a Point-to-Point Connection.....	46

9.3	Zero Configuration Networking.....	46
9.4	Configuring the Network Card.....	47
9.5	Firewall Settings.....	48
<b>10</b>	<b>Installed Software.....</b>	<b>49</b>
10.1	Operating System.....	49
10.1.1	Login.....	49
10.1.2	Windows XP Start Menu.....	50
10.2	Additional Software.....	50
10.3	Windows XP Recovery and Backup Partition.....	50
10.3.1	Performing Backup/Recovery.....	50
10.3.2	Recommended Procedure for the R&S SFE100 Models 02, 03.....	51
10.3.3	Windows XP Embedded Recovery and Backup Partition Dialog.....	51
<b>11</b>	<b>Maintenance.....</b>	<b>57</b>
11.1	Cleaning the Instrument.....	57
11.2	Replacing the Fuses.....	58
11.3	Storing the Instrument.....	58
	<b>Index.....</b>	<b>59</b>





# 1 Preface

This chapter provides safety related information, an overview of the user documentation and the conventions used in the documentation.

## 1.1 For Your Safety

The R&S SFE100 is designed for use solely in industrial and laboratory environments. Use the R&S SFE100 only in its designated purpose as described in the product documentation, for example in [Chapter 3, "System Overview"](#), on page 11. Observe the performance limits and operating conditions stated in the specifications (data sheet).

The product documentation helps you to use the R&S SFE100 safely and efficiently. Keep the product documentation in a safe place and pass it on to the subsequent users.

Safety information is part of the product documentation. It warns you about the potential dangers and gives instructions how to prevent personal injury or damage caused by dangerous situations. Safety information is provided as follows:

- In the "Basic Safety Instructions", safety issues are grouped according to subjects. For example, one subject is electrical safety. The "Basic Safety Instructions" are delivered with the R&S SFE100 in different languages.
- Throughout the documentation, safety instructions are provided when you need to take care during setup or operation.

Always read the safety instructions carefully. Make sure to comply fully with them. Do not take risks and do not underestimate the potential danger of small details such as a damaged power cable.

## 1.2 Conventions Used in the Documentation

The following conventions are used throughout this documentation.

### Typographical conventions

Convention	Description
"Graphical user interface elements"	All names of graphical user interface elements on the screen, such as dialogs, menus, options, buttons, and softkeys are enclosed by parentheses.
KEYS	Key names are written in capital letters.
File names, commands, program code	File names, commands, coding samples and screen output are distinguished by their font.
<i>Input</i>	Input to be entered by the user is displayed in italics.

Convention	Description
<a href="#">Links</a>	Links are displayed in blue font.
"References"	References to other parts of the documentation are enclosed by parentheses.

### Conventions for procedure descriptions

When describing how to operate the R&S SFE100, several alternative methods may be available to perform the same task. If possible, the procedure using the front panel is described.

The terms "select" and "press" may refer to any of the described methods, i.e. using a key on the R&S SFE100 or on a keyboard, or a mouse pointer in the display.

## 2 Documentation Overview

This chapter provides an overview of the R&S SFE100 user documentation. Unless specified otherwise, you find the documents on the R&S SFE100 product page at:

[www.rohde-schwarz.com/manual/sfe100](http://www.rohde-schwarz.com/manual/sfe100)

### 2.1 Getting Started Manual

Introduces the R&S SFE100 and describes how to set up and start working with the product. Includes a sample application and general information, e.g. safety instructions, etc. A printed version is delivered with the instrument.

### 2.2 User Manuals and Help

Contains the description of all instrument modes and functions. Also provides an introduction to remote control, a complete description of the remote control commands with programming examples, and information on maintenance, instrument interfaces and error messages. Includes the contents of the getting started manual.

The contents of the user manual is available as help in the R&S SFE100. The help offers quick, context-sensitive access to the complete information for the base unit and the software options.

For detailed information on how to use the help, refer to the chapter "Operating Concepts".

The user manual (PDF) is provided on the R&S SFE100 under:

`C:\Program Files\Rohde&Schwarz\Sfe\Docu`

If you install a new firmware version, the information in this directory is also updated.

### 2.3 Tutorials

Tutorials offer guided examples and demonstrations on operating the R&S SFE100. They are provided on the product page of the internet.

### 2.4 Basic Safety Instructions

Contains safety instructions, operating conditions and further important information. The printed document is delivered with the instrument.

## 2.5 Data Sheets and Brochures

The data sheet contains the technical specifications of the R&S SFE100. It also lists the options and their order numbers, and optional accessories.

The brochure provides an overview of the instrument and deals with the specific characteristics.

See [www.rohde-schwarz.com/brochure-datasheet/sfe100](http://www.rohde-schwarz.com/brochure-datasheet/sfe100)

## 2.6 Release Notes and Open Source Acknowledgment (OSA)

The release notes list new features, improvements and known issues of the current firmware version, and describe the firmware installation.

The open source acknowledgment document provides verbatim license texts of the used open source software. On the R&S SFE100, the open source acknowledgment document is provided as PDF file in the same directory as the user manual.

See [www.rohde-schwarz.com/firmware/sfe100](http://www.rohde-schwarz.com/firmware/sfe100)

## 2.7 Application Notes, Application Cards, White Papers, etc.

These documents deal with special applications or background information on particular topics.

See [www.rohde-schwarz.com/application/sfe100](http://www.rohde-schwarz.com/application/sfe100)

## 3 System Overview

The R&S SFE100 has been designed as a platform for different applications and for future options. It provides a number of instruments and applications and offers unrivaled RF and baseband characteristics.

Due to its modular design, the R&S SFE100 can be optimally adapted to the requirements of different applications. It is an ideal research and development tool for making improvements to introduced standards and for generating new standard signals. Applications that previously required many different instruments are now fully covered by the R&S SFE100.

The modern, intuitive concept of the R&S SFE100 ensures fast and easy operation.

You can easily switch operating parameters (e.g. roll-off, puncturing rate, QAM mode) and select operating parameters whose values exceed those defined in the standard for lab applications. For special tasks such as in DVB-T/H, modulation, individual carriers and carrier groups can be deactivated. Sweeps across the entire RF range are possible.

Main functions at a glance:

- Multi standard platform
- Realtime TV signal and audio broadcasting signal generation
- Digital and analog transmission standards
- Available as a production solution (non-realtime)
- Wide output frequency range from 100 kHz to 2.7 GHz
- Internal digital and analog interferer simulation
- Realtime transmission simulations
- TS baseband generator
- TRP and ETI player
- I/Q arbitrary waveform generator

For further details, refer to the brochure and data sheet.

### 3.1 Basic Instrument Concept

The R&S SFE100 offers a flexible hardware platform.

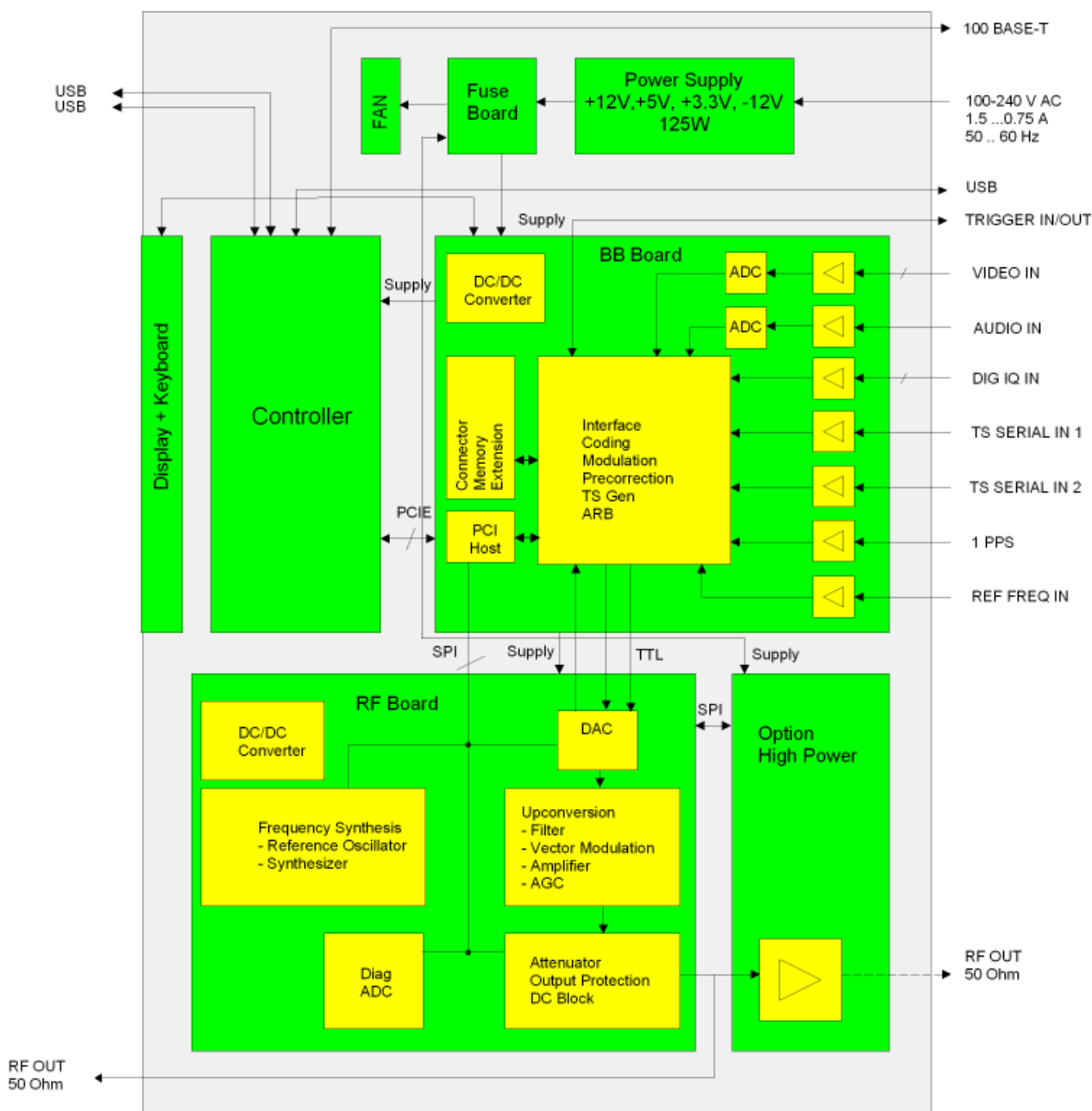

### 3.1.1 Baseband Section

The baseband section of the R&S SFE100 contains the hardware for generating and processing I/Q signals. It is entirely digital in design.

Depending on the R&S SFE100 model, the baseband section provides all of the transport stream (TS) interfaces and handles processing of the transport streams. The TS/Video generator option is also found here. The ARB hardware option can also be installed on this subassembly.

The coder part of the FPGA receives the processed transport stream signals and performs the FEC for the selected digital TV standard. The subassembly generates digital I/Q signals which are forwarded to the RF section.

Using the AWGN software option (R&S SFE100-K40 noise generator), additive white Gaussian noise (AWGN) can be generated.

### 3.1.2 RF Section

The D/A converter converts the digital signal into an analog I/Q signal. This analog I/Q signal feeds the I/Q modulator. The following part contains the synthesizer, output section with I/Q modulator, and attenuator.

The frequency range is 100 kHz to 2.7 GHz.

## 4 Setting Up the R&S SFE100

### **WARNING**

#### **Risk of injuries**

To avoid injuries to yourself or others, always follow the instructions provided in the following chapters. Furthermore, observe the general safety instructions at the beginning of this manual.

### 4.1 Unpacking the R&S SFE100

The R&S SFE100 is shipped together with its mandatory accessories in a cardboard box.

#### 4.1.1 Inspecting for Shipping Damage

Check the following. If anything is damaged, immediately notify the carrier.

1. Check the shipping container and cushioning material for damage.
2. Unpack the cardboard box (see [Chapter 4.1, "Unpacking the R&S SFE100"](#), on page 14) and check the housing and handle for visible damages or loose parts.

#### 4.1.2 Unpacking the Cardboard Box

Proceed as follows:

1. Open the cardboard box.
2. Remove the accessories packed into the box.
3. Take the R&S SFE100 out of the packaging.
4. Remove the shock protectors attached to the R&S SFE100.



Retain the original packing material. If the R&S SFE100 needs to be transported or shipped at a later date, you can use the material to prevent control elements and connectors from being damaged. Rohde & Schwarz will only accept claims of warranty if the R&S SFE100 is shipped with sufficient packaging.



### 4.1.3 Checking the Accessories

The R&S SFE100 comes with the following accessories:

- Power cable
- Getting started manual

### 4.1.4 Warranty Conditions

For information on warranty conditions for the R&S SFE100 refer to the terms of the delivery documents.

## 4.2 Putting Up the R&S SFE100

The R&S SFE100 is designed for interior use only. The R&S SFE100 can be used in standalone operation or can be installed in a rack.

### NOTICE

#### Risk of material damage

Make sure that the following conditions are met at the operation site:

- The ambient temperature does not exceed the range specified in the data sheet.
- All fan openings are unobstructed and the airflow perforations are unimpeded. The minimum distance from the wall is at least 10 cm.

Failure to meet these conditions may cause damage to the R&S SFE100 or other devices in the test setup.

If necessary, use proper protective equipment to protect DUTs against electrostatic discharge in the event of human contact.

### 4.2.1 Placing the R&S SFE100 on a Bench Top

The R&S SFE100 is designed for use under general laboratory conditions.

### WARNING

#### Risk of injuries

If the R&S SFE100 is not set up securely, you or others can be injured.

Place the R&S SFE100 on a stable and level surface. Do not place anything on top of the R&S SFE100, if the R&S SFE100 is not in a level position.

Before folding out the feet at the R&S SFE100 bottom, read the safety instructions for instruments with fold-out feet at the beginning of this manual carefully.

### 4.2.2 Mounting the R&S SFE100 in a Rack

The R&S SFE100 may be installed in a 19" rack mount by using a rack adapter kit (for order no. see data sheet). Follow the installation instructions that are part of the adapter kit.

## 5 Interfaces and Connectors

This chapter describes the front panel and the rear panel of the R&S SFE100, including all status displays and connectors. See the data sheet for information about permissible levels on the inputs and output levels on the outputs.

If you use the interfaces and connectors, take care to avoid electromagnetic interference. For details see [Chapter 6.1, "Preventing Electromagnetic Interference"](#), on page 28.

### 5.1 Front Panel

This chapter provides an overview of the controls and connectors on the front panel. Each control or connector is briefly described along with a reference to the chapter(s) containing detailed information about its usage.



**Figure 5-1: Model 02, 03**

- 1 = Hardkeys
- 2 = Status display LEDs
- 3 = Cursor keys
- 4 = Display
- 5 = USB interfaces
- 6 = RF output



**Figure 5-2: Model 12, 13**

- 1 = Status display LEDs
- 2 = USB interfaces
- 3 = RF output

#### 5.1.1 Hardkeys



Only provided by the models 02 and 03.

See (1) in [Figure 5-1](#).

For information on corresponding keys of an external keyboard see [Table 6-1](#).

During remote operation, you can use the virtual keys that are not available on the front panel. For details see the user manual or the help system.

#### **BACK**

- Deletes the character to the left of the cursor.
- Navigates back in the tree pane.

#### **OK**

- Displays the next menu level.
- Activates the editing mode for the selected numeric/alphanumeric parameter.
- Completes the data entry.  
The new value is accepted. For numeric parameters, the unit is also displayed.
- Switches the marked status parameters on/off (State On/Off).
- Confirms (OK) and closes message windows.

#### **RF ON/OFF**

Switches the RF output on or off.

#### **LOCAL**

Switches from remote control or remote operation (e.g. using Remote Desktop) to manual operation (using the front panel).

### **5.1.2 Status Display LEDs**

See (2) in [Figure 5-1](#) or (1) in [Figure 5-2](#).

The basic state is indicated by LEDs.

#### **RF ON**

Displays the status of the RF output.

- LED off: RF output is switched off.
- LED green: RF output is switched on.

#### **POWER**

Displays the power supply status.

- LED off: No power is supplied. R&S SFE100 is switched off.
- LED green: Power is supplied.

#### **REMOTE**

Displays the remote control status.

- LED off: R&S SFE100 is not used for remote control.

- LED yellow: R&S SFE100 is remote controlled.

### 5.1.3 Cursor Keys



Only provided by the models 02 and 03.

---

See (3) in [Figure 5-1](#).

UPARROW/DNARROW keys:

- In a list in editing mode, increases or decreases the parameter value.
- In a list, table, window or dialog box, scrolls vertically to select a parameter.

LEFTARROW/RIGHTARROW keys:

- In editing mode, moves the cursor in the input fields forward and back.
- In a list, table, window or dialog box, scrolls horizontally to select a parameter.

For further details see user manual or the help system.

### 5.1.4 Display



Only provided by the models 02 and 03.

---

See (4) in [Figure 5-1](#).

For details on using the front panel display see the user manual or the help system.

For information on the graphical user interface see the user manual or the help system.

### 5.1.5 RF OUT

N (50R mechanics) connector. Used to output the RF signal.

The level range can be extended upwards by installing the power amplifier option (R&S SFE100-B90). With this option installed, the output is located on the rear panel.

---

#### **NOTICE**

##### **Do not overload the RF output**

See the data sheet for the limits for the DC voltage and reverse RF power. Do not exceed these limits. Exceeding these limits can cause instrument damage.

---



### 5.1.6 USB Interfaces

See (5) in [Figure 5-1](#) or (2) in [Figure 5-2](#).

Two USB (universal serial bus) interfaces of the type A (host USB) are provided. Use the interfaces to connect external devices like a keyboard, mouse, printer, memory stick ([Chapter 6.3, "Connecting External Devices"](#), on page 29), or to perform a firmware update.



Upper connector = port 1  
Lower connector = port 3



Electromagnetic interference (EMI) can affect the measurement results. To avoid any impact, make sure that the following conditions are met:

- Use suitable double-shielded cables.
- Do not use USB connecting cables exceeding 1 m in length.
- Use only USB devices that remain within the permissible EMI limits.

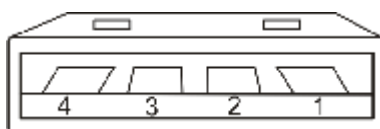

**Table 5-1: Pin assignment**

Pin	Abbreviation	Signal
1	PWR	+ 5 V / + 0.5 A max!
2	D-	Data -
3	D+	Data +
4	GND SHIELD	Ground

## 5.2 Rear Panel

This chapter provides an overview of the controls and connectors on the rear panel. Each control or connector is briefly described along with a reference to the chapter(s) containing detailed information about its usage.



### 5.2.1 AC Power Supply Connector and Switch

The IEC 320 / EN 60320 AC power supply connector and the AC power switch are combined (type C14).

A fuse holder is integrated.

The AC power switch is located on the right of the AC power connector.



Switch positions:

- I: The R&S SFE100 is in operation.
- O: The entire instrument is disconnected from the AC power supply.

For further information:

- See [Chapter 11.2, "Replacing the Fuses"](#), on page 58
- See [Chapter 6.2, "Connecting to the AC Power Supply"](#), on page 28
- See [Chapter 7, "Switching On or Off the R&S SFE100"](#), on page 33

### 5.2.2 TS1 IN / TS2 IN

BNC connector. Used to feed in a serial MPEG2 transport stream.

These inputs handle a serial signal with one of three formats:

- ASI (asynchronous serial interface)
- SMPTE 310 (Society of Motion Picture and Television Engineers)
- ETI (TS2 IN only)

To select the input, select "DIGITAL TV" menu, "INPUT SIGNAL", "INPUT". For further details see the user manual or the help system.

For the T-DMB / DAB transmission standard, TS2 IN is used as an external ETI input (ensemble transport interface). TS1 IN is not used for T-DMB/DAB. TS2 IN is conform to the ETS 300 799 specification. ETI NI (network independent) and ETI NA 5592 or ETI NA 5376 (network adaptation) signals are accepted.



### 5.2.3 VIDEO IN

BNC connector. Video input for the ATV transmission standards.



### 5.2.4 AUDIO AUX

9 pin SUB-D connector for multi purpose input.

- Audio IN
- BTSC IN
- NICAM IN
- REF FREQ OUT / Trigger OUT

A signal is present on the reference frequency output pin (TRIG / REF OUT) if it is activated.

For further details see user manual or the help system.

When using an internal reference, the frequency generated by the internal reference oscillator of the R&S SFE100 is made available. If an external reference is activated, the signal applied to REF IN is also available on REF OUT pin. It is buffered and filtered.





Table 5-2: Pin assignment

Pin	Description
1	Ground
2	Ground
3	AF2 - (Audio IN)
4	AF2 + (Audio IN)
5	BTSC IN
6	AF1 - (Audio IN)
7	AF1 + (Audio IN)
8	REF FREQ OUT / Trigger Out
9	NICAM IN

### 5.2.5 MONITOR

HDMI interface to connect an external monitor. For further details refer to [Chapter 6.3.4, "External Monitor"](#), on page 31.



### 5.2.6 100 BASE-T

1 Gigabit LAN interface (100 Base-T).

Used to connect the R&S SFE100 to a local network for remote control, remote operation, printouts and data transfer. The assignment of the RJ.45 CAT5 connector supports twisted pair category 7 UTP/STP cables in a star configuration (UTP stands for "unshielded twisted pair", and STP for "shielded twisted pair").





Do not connect or disconnect the network cable until the instrument is switched off. Otherwise, the network connection cannot be reliably detected.

Electromagnetic interference (EMI) can affect the measurement results. To avoid any impact, use category 7 cables.

For further information:

- See [Chapter 9, "Operating the R&S SFE100 in a LAN"](#), on page 45
- See user manual or the help system for remote control using the Ethernet

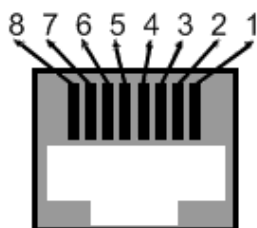

Table 5-3: Pin assignment

Pin	Abbreviation	Signal
1	TXD+	Transmit data, positive
2	TXD-	Transmit data, negative
3	RXD+	Receive data, positive
4, 5	R0	Termination, 75R
6	RXD-	Receive data, negative
7, 8	R1	Termination, 75R

## 5.2.7 DIG I/Q

Requires the extended I/Q input option (R&S SFE100-K80). Used to receive digital I/Q signals from another R&S instrument with the same interface.

For further details see the user manual or the help system.



### 5.2.7.1 DIG I/Q IN

Digital I/Q input of the R&S SFE100.

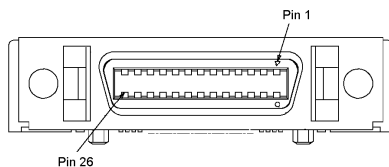

Table 5-4: Input pin assignment

Pin	Name	Signal
1	DIG_IQ_CLK2+	Data clock 2 (control signal)
2	GND	Ground (control signal)
3	DIG_IQ_IN_D0+	Data bit (LSB), OUT/IN 0 line (I/Q signal)
4	DIG_IQ_IN_D1+	Data bit, OUT/IN 1 line (I/Q signal)
5	DIG_IQ_IN_D2+	Data bit, OUT/IN 2 line (I/Q signal)
6	DIG_IQ_IN_CLK1+	Data clock 1 (I/Q signal)
7	DIG_IQ_IN_SCLK	Serial clock (control signal)
8	+U5V2	+5 V (control signal)
9	DIG_IQ_IN_D3+	Data bit, OUT/IN 3 line (I/Q signal)
10	DIG_IQ_IN_D4+	Data bit, OUT/IN 4 line (I/Q signal)
11	DIG_IQ_IN_D5+	Data bit, OUT/IN 5 line (I/Q signal)
12	DIG_IQ_IN_D6+	Data bit, OUT/IN 6 line (I/Q signal)
13	DIG_IQ_IN_D7+	Data bit (MSB), OUT/IN 7 line (I/Q signal)
14	DIG_IQ_CLK2-	Data clock 2 (control signal)
15	DIG_IQ_IN_D0-	Data bit (LSB), OUT/IN 0 line (I/Q signal)
16	DIG_IQ_IN_D1-	Data bit, OUT/IN 1 line (I/Q signal)
17	DIG_IQ_IN_D2-	Data bit, OUT/IN 2 line (I/Q signal)
18	DIG_IQ_IN_CLK1-	Data clock 1 (I/Q signal)
19	GND	Ground (control signal)
20	DIG_IQ_IN_SDAT	Serial data (control signal)
21	DIG_IQ_IN_D3-	Data bit, OUT/IN 3 line (I/Q signal)
22	DIG_IQ_IN_D4-	Data bit, OUT/IN 4 line (I/Q signal)
23	DIG_IQ_IN_D5-	Data bit, OUT/IN 5 line (I/Q signal)
24	DIG_IQ_IN_D6-	Data bit, OUT/IN 6 line (I/Q signal)
25	DIG_IQ_IN_D7-	Data bit (MSB), OUT/IN 7 line (I/Q signal)
26	GND	Ground (control signal)

Line pairs have a name that only differs in the last character. For example, the pins 1 and 14 are a pair.

### 5.2.8 USB Interface

USB interface (universal serial bus) type A (host USB). For details see [Chapter 5.1.6, "USB Interfaces"](#), on page 20.



### 5.2.9 REF IN

BNC connector. Used to input the reference frequency.  
For further details see user manual or the help system.



### 5.2.10 1PPS / TRIG

BNC connector. Input for the 1 pulse per second signal used in SFN modes.  
Input for external triggering of digital modulations standards and ARB.



### 5.2.11 RF OUT

Requires the power amplifier option (R&S SFE100-B90). For details see [Chapter 5.1.5, "RF OUT"](#), on page 19.



## 6 Connecting the R&S SFE100

This chapter describes how to connect the R&S SFE100 to the power supply and external devices.

### 6.1 Preventing Electromagnetic Interference

To prevent electromagnetic interference, the R&S SFE100 must be operated with all shielding covers fitted. Only suitable and shielded signal and control cables may be used.

#### RF/ASI/TRIGGER inputs and outputs

In particular cables that are connected to these inputs/outputs can cause EMC problems. Therefore these cables should have at least 80 dB to 1 GHz shielding. This is usually achieved by means of double-shielded cables.

#### USB interfaces

To connect the USB interfaces, only use peripheral equipment that does not cause limit violations. For details see [Chapter 5.1.6, "USB Interfaces"](#), on page 20.

#### HDMI interface

To connect the HDMI interface, only use peripheral equipment that does not cause limit violations. For details on the interface see [Chapter 5.2.5, "MONITOR"](#), on page 23.

#### LAN interface (100 BASE-T)

To connect the LAN interface (100 BASE-T), use a suitable cable. For details see [Chapter 5.2.6, "100 BASE-T"](#), on page 23.

### 6.2 Connecting to the AC Power Supply

The R&S SFE100 can be used with different AC power voltages and adapts itself automatically to it. Adjusting the R&S SFE100 to a particular AC supply voltage is therefore not required. Refer to the data sheet for the requirements of voltage and frequency.

**⚠ WARNING****Shock hazard**

Observe the basic safety instructions at the beginning of this manual, especially the instructions on electrical safety.

Take care that the AC voltage lies within the limits printed on the AC power connector of the R&S SFE100 and listed in the data sheet.

- ▶ Connect the R&S SFE100 to the AC power supply, using the power cable that is supplied. The AC power connector is located on the rear panel of the R&S SFE100.  
Since the R&S SFE100 complies with safety class EN61010-1, it should only be connected to a socket with a ground contact.

For further information see [Chapter 5.2.1, "AC Power Supply Connector and Switch"](#), on page 21.

## 6.3 Connecting External Devices

Using the USB interfaces, you can directly connect USB devices to the R&S SFE100. This number can be increased as necessary by using USB hubs.

Due to the large number of available USB devices, there is almost no limit to the possible expansions. In the following, USB devices that can be useful are listed.

- Keyboard for entering comments, file names, etc. or for easy access to Windows XP settings. See [Chapter 6.3.1, "External Keyboard"](#), on page 30.
- Mouse for easy operation of Windows dialogs. See [Chapter 6.3.2, "Mouse"](#), on page 31.
- Memory stick for easy transfer of data to/from a computer (e.g. firmware updates). See [Chapter 6.3.3, "Memory Stick"](#), on page 31.
- CD-ROM drives for installing software.
- Printer for printing out measurement results.

### To install a USB device

1. Connect the USB device to the R&S SFE100. You can do this during operation because all USB devices are Plug and Play.  
Windows XP automatically searches for a suitable device driver.
2. If Windows XP does not find a suitable driver, it will prompt you to specify a directory that contains the driver software. If the driver software is on a CD-ROM, connect a USB CD-ROM drive to the R&S SFE100 before proceeding.

### To uninstall a USB device

- ▶ Disconnect the USB device from the R&S SFE100. You can do this during operation.

Windows XP immediately detects the change in the hardware configuration and deactivates the corresponding driver.

## 6.3.1 External Keyboard

Connect the keyboard to one of the USB interfaces (type A). The default language setting is for a UK keyboard. You can change the language and modify other settings such as the repetition rate in Windows XP.

### Changing Regional and Language Settings

1. Open the "Start" menu by pressing the WINDOWS key on an external keyboard.
2. Select "Control Panel" and then "Keyboard" or "Regional and Language Options".

**Table 6-1: Corresponding keys: front panel - external keyboard (model 02, 03)**

Key on front panel	Corresponding key on keyboard	Function description
Cursor keys	LEFTARROW, RIGHTARROW, UPARROW, DNARROW	See <a href="#">Chapter 5.1.3, "Cursor Keys"</a> , on page 19
BACK	BACKSPACE	See <a href="#">Chapter 5.1.1, "Hardkeys"</a> , on page 17
OK	ENTER	"
LOCAL	F3	"
RF ON/OFF	CTRL+F1	"

During remote operation, you can use the following virtual keys provided in the "HARD-KEY" menu. These keys are not available on the front panel.

**Table 6-2: Corresponding keys: virtual keys - external keyboard**

Virtual key	Corresponding key on keyboard	Function description
HELP	F1	Opens and closes the context-sensitive help function. For details see user manual or the help system
ASSIGN	F2	Starts management of favorites. For details see user manual or the help system
LOCAL	F3	Switches from remote control or remote operation to manual operation. For details see user manual or the help system



Virtual key	Corresponding key on keyboard	Function description
PRESET	F4	Sets the instrument to a defined state. For details see user manual or the help system
FILE	F5	Opens the menu for saving instrument settings. For details see user manual or the help system
SETUP	F6	Opens the setup menu for general instrument settings. For details see user manual or the help system
HOME	F8	Resets tree navigation. For details see user manual or the help system
APPL	F9	Selects another application. For details see user manual or the help system

### 6.3.2 Mouse

You can change settings such as the speed of the mouse cursor in Windows XP.

#### Changing Mouse Settings

1. Open the "Start" menu by pressing the WINDOWS key on an external keyboard.
2. Select "Control Panel" and then "Mouse".

### 6.3.3 Memory Stick

The R&S SFE100 has a disk drive. You can exchange data by using a memory stick which you plug into one of the USB interfaces. The memory stick is automatically assigned a free drive letter and you can use Windows Explorer to transfer data.

### 6.3.4 External Monitor

R&S SFE100s with the following serial numbers have a HDMI interface to connect an external monitor with a DVI-D interface:

- Model 02 from serial number 120600
- Model 03 from serial number 130600
- Model 12 from serial number 140000

To connect the monitor, use a HDMI to DVI adapter or a HDMI to DVI cable. For details on the HDMI interface see [Chapter 5.2.5, "MONITOR"](#), on page 23.

If you have used the R&S SFE100 without monitor before, activate the HDMI interface by pressing the CTRL+ALT+F4 key combination, several times if necessary.

For R&S SFE100s without HDMI interface, it is possible to display the screen contents on external monitors by using remote operation on an external computer.

For details on remote operation see the user manual or the help system.

## 7 Switching On or Off the R&S SFE100

### **⚠ WARNING**

#### **Shock hazard**

Observe the basic safety instructions at the beginning of this manual, especially the instructions on electrical safety.

### 7.1 Switching On the R&S SFE100

#### **NOTICE**

#### **Risk of instrument damage**

Before switching on the R&S SFE100, make sure that the following conditions are met:

- The R&S SFE100 is set up as described in [Chapter 4, "Setting Up the R&S SFE100"](#), on page 14.
- Signal levels at the input connectors are all within the specified ranges.
- Signal outputs are correctly connected and are not overloaded. In particular, do not exceed the maximum permissible reverse power allowed at the RF output.

The values are specified in the data sheet. Failure to meet these conditions may cause damage to the R&S SFE100 or other devices in the test setup.

#### **To switch on the R&S SFE100**

1. Make sure that the R&S SFE100 is connected to a power supply (for details see [Chapter 6.2, "Connecting to the AC Power Supply"](#), on page 28).
2. Press the AC power switch on the rear panel into I position (for details see [Chapter 5.2.1, "AC Power Supply Connector and Switch"](#), on page 21).

The R&S SFE100 starts booting:

- The installed BIOS version and some of the computer features are displayed on the screen for a few seconds.
- The Windows XP Embedded operating system is booted, followed by the R&S SFE100 firmware.
- A self-test is performed.

After booting is completed, the main screen of the R&S SFE100 is displayed, and the R&S SFE100 is ready for operation.

If the external monitor remains dark, proceed as described in [Chapter 6.3.4, "External Monitor"](#), on page 31.

The configuration settings that were active before the R&S SFE100 was last switched off are automatically restored.

Use the "FILE" menu to load another instrument setting. For details see the user manual or the help system.

## 7.2 Switching Off the R&S SFE100

### NOTICE

#### Risk of losing data

If you set the power switch to the O position before the R&S SFE100 settings have been saved, the current settings will be lost.

#### To switch off the R&S SFE100

1. Check the status displays on the front panel of the R&S SFE100. If the REMOTE status display on the front panel is on, do not switch off the R&S SFE100. Someone else is using the R&S SFE100 by means of remote control (see also [Chapter 5.1.2, "Status Display LEDs"](#), on page 18).
2. Set the AC switch on the rear panel of the R&S SFE100 to the O position.  
None of the LEDs on the front panel should be lit.

## 7.3 Checking the Provided Options

The R&S SFE100 may be equipped with options. In order to check whether the installed options correspond to the options indicated on the delivery note, proceed as follows.

Connect an external monitor ([Chapter 6.3.4, "External Monitor"](#), on page 31) or use remote operation (for details see user manual).

1. In the "HARDKEY" menu, select "SETUP".
2. In the tree, select "INFO HARDWARE" to display a list showing the currently installed hardware.
3. Check the availability of the hardware options as indicated in the delivery note.
4. In the tree, select "SOFTWARE OPTIONS" and then "ACTIVE OPTIONS" to display a short tabular overview of the enabled software options.
5. Check the availability of the software options as indicated in the delivery note.

For further details see the user manual or the help system.

For an overview of the all options available for the R&S SFE100 refer to the Rohde & Schwarz Homepage.

## 7.4 Turn-On Tests

If an error is detected, an error indication is displayed in the error/warnings line along with a brief description of the error.

- ▶ To obtain more information about the error, press the "ERROR/WARNING DETAILS" softkey.

A description of the error(s) or warning(s) is displayed.

For further details see the user manual or the help system.

Besides automatic monitoring of instrument functions, the R&S SFE100 also offers the following way of ensuring proper operation.

### System adjustment

Use the SETUP menu to carry out an internal adjustment. This is a way of obtaining the best possible level accuracy, for example.

1. In the "HARDKEY" menu, select "SETUP".
2. In the tree, select "ADJUSTMENT".

For further details see the user manual or the help system.

## 8 Sample Application

The following example involves the following main steps:

- Feed an MPEG2 transport stream to the R&S SFE100 using the serial interface 1 (TS1 IN, see [Chapter 5.2.2, "TS1 IN / TS2 IN"](#), on page 21) on the rear panel.
- This MPEG2 transport stream undergoes channel encoding and modulation for transmission in compliance with the DVB-C specification. To achieve this, perform the following step-by-step instructions. The involved settings are summed up in [Table 8-1](#).
- The result is output as an RF signal on the RF output.

**Table 8-1: Involved settings**

Parameter	Value
Center frequency	330 MHz
Level	-20.0 dBm
Transmission standard	DVB-C
Constellation	64 QAM
Symbol rate	6.9 MS/s
Roll off	0.15

If you connect an external monitor, keyboard and mouse (see [Chapter 6.3, "Connecting External Devices"](#), on page 29) or operate the R&S SFE100 using an external computer, you can use the graphical user interface. The following step-by-step instructions describe how to perform the sample application. If your R&S SFE100 provides a display and keys on the front panel (models 02 and 03), you can also use those for operation. The involved steps are described in [Chapter 8.1, "Using Display and Keys on the Front Panel"](#), on page 41.



If your model provides a display and keys on the front panel, you can alternatively proceed as described under [Chapter 8.1, "Using Display and Keys on the Front Panel"](#), on page 41.

An explanation of the graphical user interface and information on how to select items, open lists and enter parameters are provided in the user manual or the help system.

### Selecting the transmitter application (TX)

1. In the "HARDKEY" menu, select "APPL".
2. Select the TX application (DVB-C transmission is a transmitter application).
3. Press the ENTER key.  
The TX application is displayed.

### Setting the output frequency

1. In the tree, select the "FREQUENCY" menu.

2. Press the ENTER key.

The tree is expanded and the "FREQUENCY" submenu is displayed.

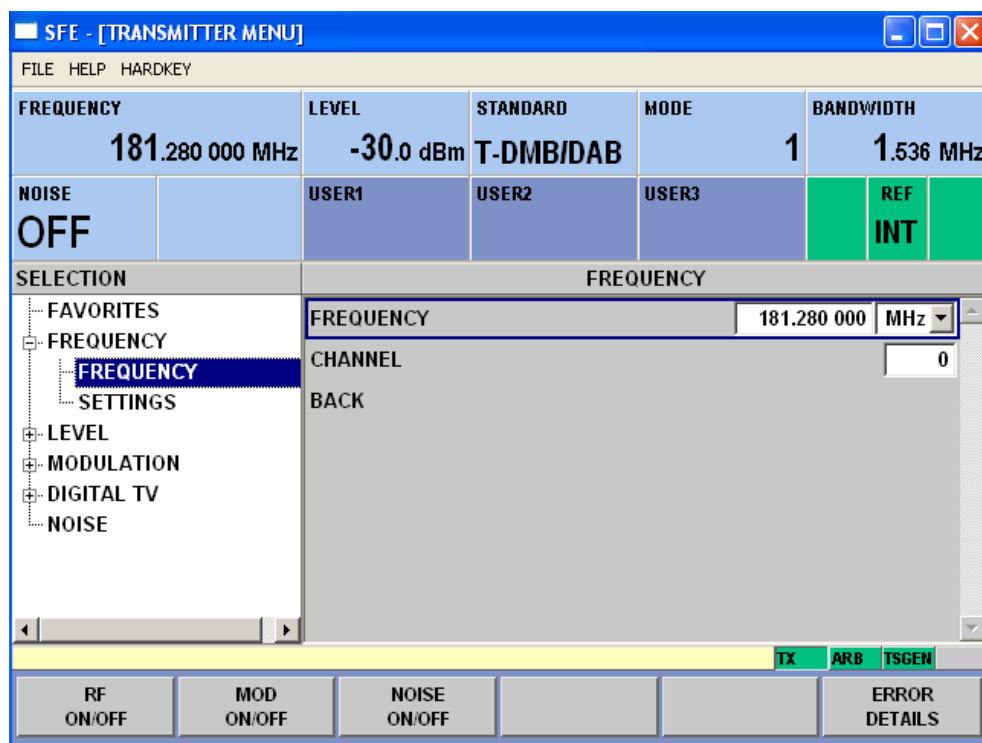

3. In the tree, select the "FREQUENCY" submenu.

4. Press the ENTER key.

The focus is set on the work view.

5. Set a frequency of 330 MHz.
  - a) Select the "FREQUENCY" field.
  - b) Enter 330.
  - c) Press the ENTER key.

The entered frequency is displayed in the info area.

### Setting the output level

1. In the tree, select the "LEVEL" menu.

2. Press the ENTER key.

The tree is expanded and the "LEVEL" submenu is displayed.

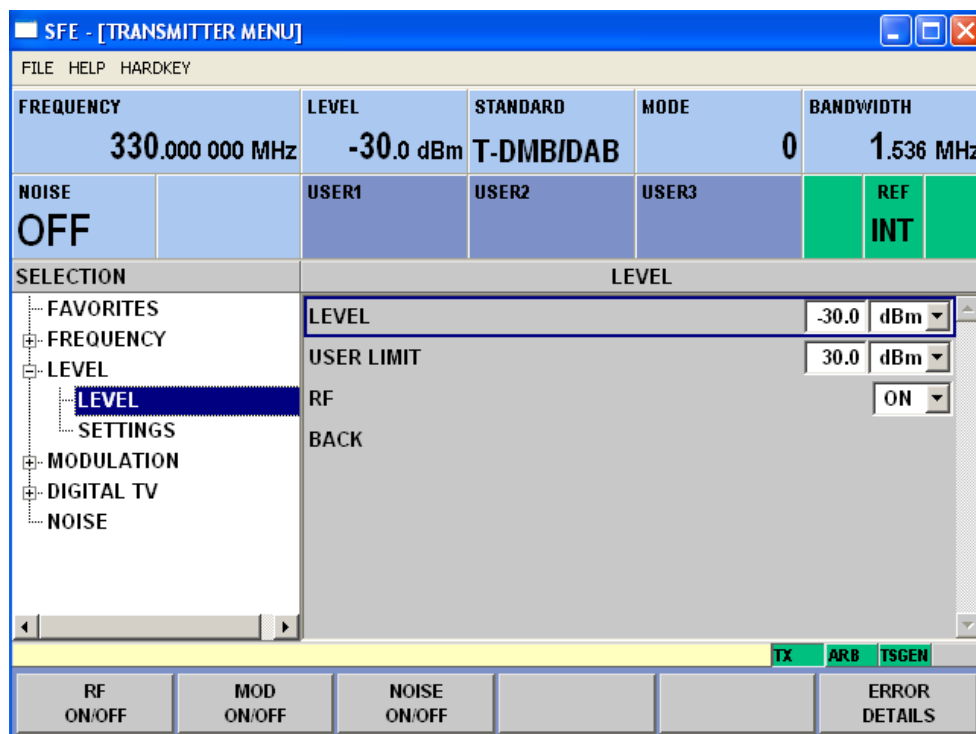

3. In the tree, select the "LEVEL" submenu.
4. Press the ENTER key.  
The focus is set on the work view.
5. Set a level of -20 dBm.
  - a) Select the "LEVEL" field.
  - b) Enter -20.
  - c) Press the ENTER key.
  - d) If you want to enter the level in a different unit, change the unit in the "LEVEL" menu, under "SETTINGS" / "LEVEL UNIT" first (see user manual or help system).

The entered level is displayed in the info area.

### Setting the modulation parameters and selecting the transmission standard

1. In the tree, select the "MODULATION" menu.
2. Press the ENTER key.  
The tree is expanded and the "MODULATION" submenu is displayed.



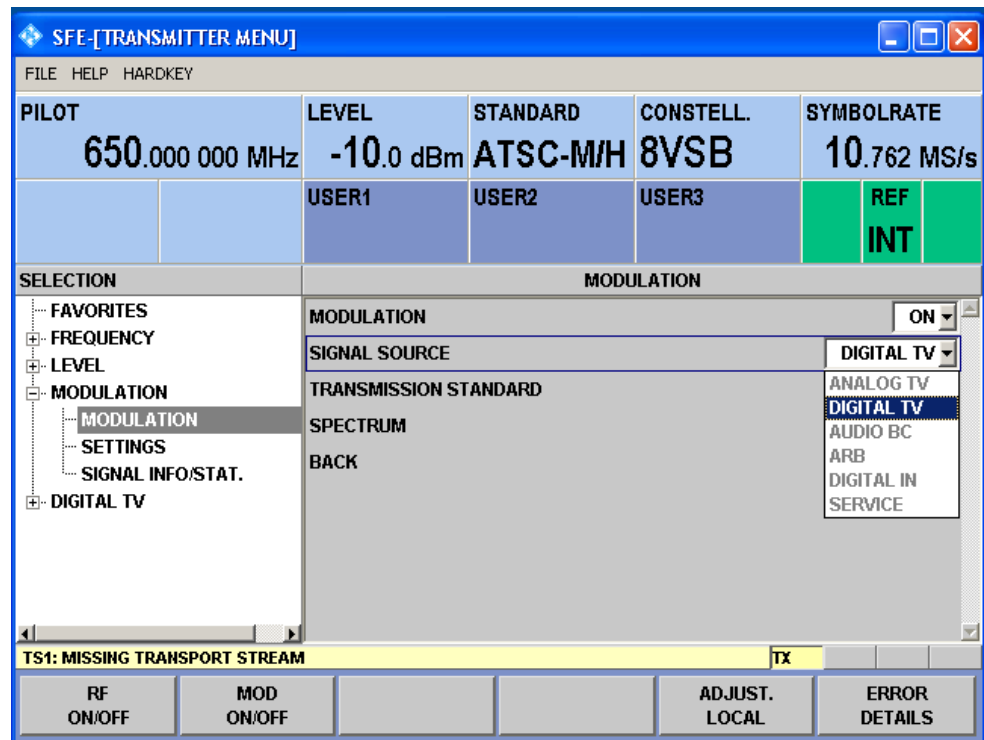

3. In the tree, select the "MODULATION" submenu.
4. Press the ENTER key.  
The focus is set on the work view.
5. Activate the modulation.
  - a) Select the "MODULATION" field.
  - b) Press the ENTER key to display the list.
  - c) Select "ON".
  - d) Press the ENTER key to confirm the selection.
6. Select the "DIGITAL TV" signal source.
  - a) Select the "SIGNAL SOURCE" field.
  - b) Press the ENTER key to display the list.
  - c) Depending on the R&S SFE100 model, if not fixed, select "DIGITAL TV".
  - d) Press the ENTER key to confirm the selection.
7. Depending on the installed options, select the "DVB-C" transmission standard.
  - a) Select the "TRANSMISSION STANDARD" field.
  - b) Press the ENTER key to display the list.
  - c) Select "DVB-C".
  - d) Press the ENTER key to confirm the selection.

The selected standard is displayed in the info area.

The I/Q modulation is switched on, the internal coder is selected as the signal source, and the DVB-C transmission standard is set.

### Selecting the transport stream input and setting the DVB-C transmission parameters

1. In the tree, select the "DIGITAL TV" menu.
2. Press the ENTER key.  
The tree is expanded and the "DIGITAL TV" submenu is displayed.  
(See [Figure 8-1](#).)
3. In the tree, select the "INPUT SIGNAL" submenu.
4. Press the ENTER key.  
The focus is set on the work view.

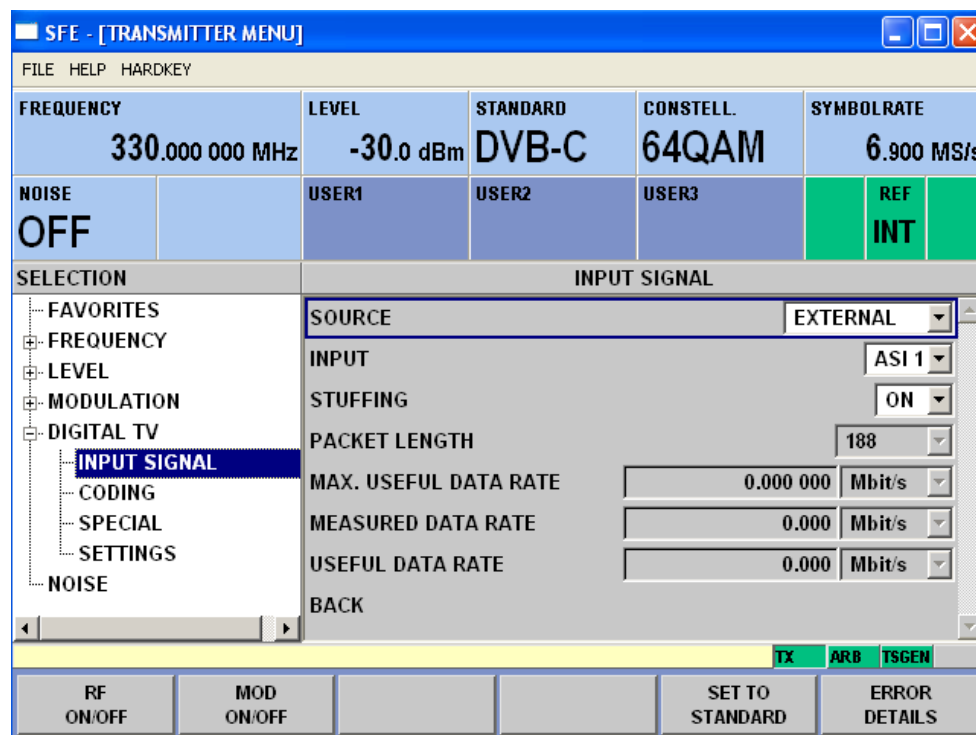

Figure 8-1: DIGITAL TV menu

5. Select the "EXTERNAL" signal source.
  - a) Select the "SOURCE" field.
  - b) Press the ENTER key to display the list.
  - c) Select "EXTERNAL".
  - d) Press the ENTER key to confirm the selection.
6. Select the "ASI 1" input.
  - a) Select the "INPUT" field.
  - b) Press the ENTER key to display the list.
  - c) Select "ASI 1".
  - d) Press the ENTER key to confirm the selection.

7. Make sure that the "STUFFING" field in the work view is set to "ON".  
This ensures that the incoming transport stream will be adapted to the proper data rate of the coder. The data rate of the coder will depend on the transmission parameters. The data stream is padded with null packets to allow adaptation to the transmission parameters.
  - a) Select the "STUFFING" field.
  - b) Press the ENTER key to display the list.
  - c) Select "ON".
  - d) Press the ENTER key to confirm the selection.
8. Select "BACK" and press the ENTER key.  
The focus is set to the tree.
9. In the tree, select the "CODING" submenu.
10. Press the ENTER key.  
The focus is set on the work view.
11. Select a symbol rate of 6.9 .MS/s.
  - a) Select the "SYMBOL RATE" field.
  - b) Enter 6.9.
  - c) If the units field to the right shows "MS/s", press the ENTER key.
  - d) If the units field indicates another unit, select this field. Press the ENTER key, and select the "MS/s" unit. Press the ENTER key twice to confirm the unit and the symbol rate.

The selected symbol rate is displayed in the info area.
12. Select the "64 QAM" constellation.
  - a) Select the "CONSTELLATION" field.
  - b) Press the ENTER key to display the list.
  - c) Select "64 QAM".
  - d) Press the ENTER key to confirm the selection.

The selected constellation is displayed in the info area.

## 8.1 Using Display and Keys on the Front Panel



A display and keys on the front panel are only provided by the R&S SFE100 models 02 and 03.

For details on using the front panel display see the user manual or the help system.

### Setting the output frequency

1. Press OK to enter tree operation.

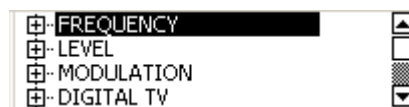

- Using the UPARROW/DNARROW keys, select the "FREQUENCY" menu.
- Press the OK or RIGHTARROW key.

The tree is expanded and the "FREQUENCY" submenu is displayed.



- Select the "FREQUENCY" submenu and confirm your entry with OK.

The work view is displayed.

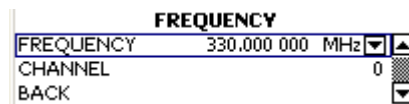

- Using the UPARROW/DNARROW keys, select the "FREQUENCY" field.
- Using the LEFTARROW/RIGHTARROW keys, move the cursor to the digit you want to change in the frequency entry.
- Using the UPARROW/DNARROW keys, change the numeric value to 330 MHz.
- Press OK to confirm your entry.
- Press the BACK key to exit the work view and get back to the tree.

### Setting the output level

- Using the UPARROW/DNARROW keys, select the "LEVEL" menu.
- Press the OK or RIGHTARROW key.

The tree is expanded and the "LEVEL" submenu is displayed.

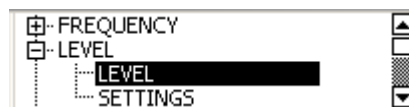

- Select the "LEVEL" submenu and confirm your entry with OK.

The work view is displayed.

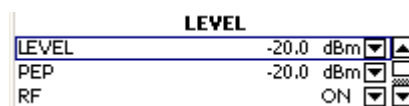

- Using the UPARROW/DNARROW keys, select the "LEVEL" field.
- Using the LEFTARROW/RIGHTARROW keys, move the cursor to the digit you want to change in the frequency entry.
- Using the UPARROW/DNARROW keys, change the numeric value to -20 dBm.

7. Press OK to confirm your entry.
8. Press the BACK key to exit the work view and get back to the tree.

### Setting the modulation parameters and selecting the transmission standard

Depending on the R&S SFE100 model, the signal source and the transmission standard are fixed to "DTV" and "DVBC" under "MODULATION".

### Selecting the transport stream input and setting the DVB-C transmission parameters

1. Using the UPARROW/DNARROW keys, select the "DIGITAL TV" menu.
2. Press the OK or RIGHTARROW key.

The tree is expanded and the "DIGITAL TV" submenu is displayed.

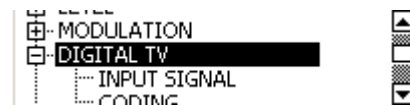

3. Select the "INPUT SIGNAL" submenu and confirm your entry with OK.

The work view is displayed.

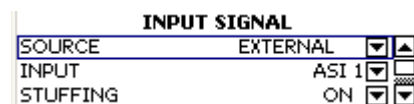

4. Select the "EXTERNAL" source.
  - a) Using the UPARROW/DNARROW keys, select the "SOURCE" field.
  - b) Press OK to open the list.
  - c) Using the UPARROW/DNARROW keys, select "EXTERNAL".
  - d) Press OK to confirm your entry.
5. Select the "ASI 1" input.
  - a) Using the UPARROW/DNARROW keys, select the "INPUT" field.
  - b) Press OK to open the list.
  - c) Using the UPARROW/DNARROW keys, select "ASI 1".
  - d) Press OK to confirm your entry.
6. Make sure that the "STUFFING" field in the work view is set to "ON".  
This ensures that the incoming transport stream will be adapted to the proper data rate of the coder. The data rate of the coder will depend on the transmission parameters. The data stream is padded with null packets to allow adaptation to the transmission parameters.
7. Press the BACK key to exit the work view and get back to the tree.
8. Select the "CODING" submenu and confirm your entry with OK.  
The work view is displayed.

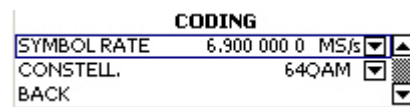

9. Select a symbol rate of 6.9 MS/s.
  - a) Using the UPARROW/DNARROW keys, select the "SYMBOL RATE" field.
  - b) Using the LEFTARROW/RIGHTARROW keys, move the cursor to the digit you want to change in the frequency entry.
  - c) Using the UPARROW/DNARROW keys, change the numeric value to 6.9 MS/s.
  - d) Press OK to confirm your entry.
10. Select the "64QAM" constellation.
  - a) Using the UPARROW/DNARROW keys, select the "CONSTELLATION" field.
  - b) Press OK to open the list.
  - c) Using the UPARROW/DNARROW keys, select "64QAM".
  - d) Press OK to confirm your entry.

All parameters listed in [Table 8-1](#) are now set.

If no further keys are pressed, after a short time, the info area is redisplayed.

## 9 Operating the R&S SFE100 in a LAN

The R&S SFE100 is equipped with a network interface and can be connected to an Ethernet LAN (local area network). The network card operates with 100 MBit Ethernet IEEE 802.3u. The TCP/IP network protocol and the associated network services are preconfigured.

To be able to exchange data within a local area network (LAN), every computer or instrument that is connected must have a unique IP address or a unique computer name. Access between different users is managed with access authorizations.

Provided the appropriate rights have been assigned and the Windows XP firewall configuration is adapted accordingly, the interface can be used e.g. for transferring data, printing on network printers, operating the R&S SFE100 from a remote computer.

To use network resources, access must be granted. To share files on the R&S SFE100 with other network users, access to instrument resources, e.g. the hard drives, must also be granted. All these administration tasks are normally performed by a network administrator using the Windows XP Start menu (for details refer to the Windows XP help system). Contact your network administrator for access authorizations.

User name and password of the R&S SFE100 are factory-set. The user name is used for auto login, access authorization and remote operation.

For further information:

- See [Chapter 10.1.1, "Login"](#), on page 49
- See [Chapter 5.2.6, "100 BASE-T"](#), on page 23
- See the user manual or help system for details on remote operation.

### 9.1 Connecting the R&S SFE100 to the Network

#### **NOTICE**

##### **Risk of network failure/virus infection**

Before connecting the R&S SFE100 to the network or configuring the network, do the following:

- Consult your network administrator.
- If your network does not support DHCP or if you choose to disable dynamic TCP/IP configuration, you must assign valid address information before connecting the R&S SFE100 to the LAN.

Errors may affect the entire network.

Efficient virus protection is a prerequisite for secure operation in the network. Never connect the R&S SFE100 to a network without proper protection against a virus infection, as doing so may cause damage to the instrument software.

**To connect the R&S SFE100 to the network**

1. Fulfill all prerequisites mentioned above.
2. Make sure that the R&S SFE100 is switched off. This is the only way to ensure that the network connection is reliably detected and any disruptions during the operation of the R&S SFE100 are avoided.
3. Connect the R&S SFE100 to the network using a CAT-5 RJ-45 cable.
4. Switch on the R&S SFE100.

**To disconnect the R&S SFE100 from the network**

1. Make sure that the R&S SFE100 is switched off.
2. Disconnect the R&S SFE100 from the network.

## 9.2 Establishing a Point-to-Point Connection

To set up a single network (a LAN connection between an R&S SFE100 and a single computer without integration into a larger network), an IP address needs to be assigned to the R&S SFE100 and the computer. The IP addresses 192.168.xxx.yyy are available for use here. xxx and yyy can assume values of 1 to 254, and the value for the subnet mask is 255.255.255.0.

- ▶ Connect the R&S SFE100 and the computer with a standard RJ-45 cross-over cable.

## 9.3 Zero Configuration Networking



This service is available in firmware version V02.60 and later.

The R&S mDNS Service is installed with the firmware. Using this service, you can connect to a network automatically. You do not need to set up services, such as dynamic host configuration protocol (DHCP) and domain name system (DNS), or configure the network settings manually (see [Chapter 9.4, "Configuring the Network Card"](#), on page 47).



## 9.4 Configuring the Network Card

Under Windows XP, network card drivers do not need to be installed separately. If the R&S SFE100 is connected to the LAN, Windows XP automatically detects the network connection and activates the required drivers.

The configuration tasks depend on whether your network has a DHCP server or not. If necessary, ask your network administrator.



If you use the R&S mDNS Service, you do not need to configure at all. For details see [Chapter 9.3, "Zero Configuration Networking"](#), on page 46.

### Networks with DHCP Server

The R&S SFE100 is preconfigured for networks using the dynamic host configuration protocol (DHCP). In such networks, the instrument is automatically assigned a free IP address. Identification in the network is based on the use of a unique computer name.

Every instrument is assigned an individual computer name at the factory. It is displayed as part of the window title of the application.

If necessary, you can change the computer name using the firmware or the Windows XP Start menu (for details refer to the Windows XP help system).

### Querying the computer name using the firmware

1. If the R&S SFE100 has a default computer name, the computer name is displayed as part of the window title of the application.

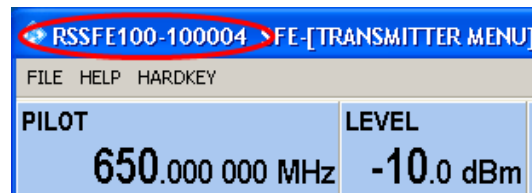

2. If no default computer name is displayed, do the following.
  - a) Press the SETUP key.
  - b) In the tree, select "COMMUNICATION".
  - c) Read out the computer name from the "FULL COMPUTER NAME" field.

### Networks without DHCP Server

In networks that assign fixed IP addresses, the network administrator usually configures the network card. Contact your network administrator. The IP address is set using the firmware or the Windows XP Start menu (for details refer to the Windows XP help system).

### Entering the IP address using the firmware

1. Press the SETUP key.

2. In the tree, select "COMMUNICATION".
3. Enter the IP address in the "TCP/IP ADDRESS" field.

## 9.5 Firewall Settings

By default, the Windows Firewall is activated to protect the R&S SFE100 from an attack of hostile users and programs. The Windows Firewall suppresses all network communication which is not initialized by the R&S SFE100 itself or which is not defined as an exception.

To enable data transfer or to allow access to the R&S SFE100, define exceptions using the Windows XP Start menu. For details refer to the Windows XP help system or contact your network administrator for support.

## 10 Installed Software

The firmware and the operating system are already installed on the R&S SFE100.

For further information:

- Performing a firmware update: see the release notes.
- Installing software options: see the user manual or the help system.

### 10.1 Operating System

The R&S SFE100 is equipped with the Windows XP Embedded operating system. When the R&S SFE100 is delivered, the operating system is configured for optimum operation. Changes to the system settings are required only if you install peripherals such as a keyboard and printer or if you configure the network and the settings do not conform to the default settings.

#### **NOTICE**

##### **Risk of causing instrument unusability**

To prevent malfunctions and to avoid instrument repair, only install service packs approved by Rohde & Schwarz.

In particular, do not use service packs for Windows XP Home Edition or Professional Edition.

#### 10.1.1 Login

Windows XP requires that you identify yourself by entering a user name and password in a login window. The R&S SFE100 provides a factory-installed auto login function, i.e. login is carried out automatically in the background. The ID used for auto login has administrator rights.



As user name and password, *instrument* are factory-set.

If the R&S SFE100 is connected to a network and if the user name and the password are identical under Windows XP and on the network, you log on to operating system and the network at the same time.

### 10.1.2 Windows XP Start Menu

The Windows XP Start menu provides access to the Windows XP functionality and installed programs. Under "Control Panel", the system settings are grouped. For details refer to the Windows XP help system.

## 10.2 Additional Software

### NOTICE

#### Risk of causing instrument unusability

The instrument is equipped with the Windows XP operating system. Additional software can therefore be installed on the instrument. The use and installation of additional software may impair instrument function. Thus, run only programs that Rohde & Schwarz has tested for compatibility with the instrument software.

The drivers and programs used on the instrument under Windows XP have been adapted to the instrument. Existing instrument software must always be modified using only update software released by Rohde & Schwarz.

## 10.3 Windows XP Recovery and Backup Partition

The R&S SFE100 provides a backup and recovery partition. A backup of the factory system partition (C:\) is stored per default and can be recovered in case of a system crash.

Only R&S SFE100 models 12, 13:

In addition, backups of up to 5 firmware versions can be stored on this partition. For example, it is possible to backup the current system partition prior to a firmware update or to provide different system configurations for different environments. When recovered, the system partition (C:/) is deleted, formatted and written newly. The data partition (D:\) is not affected.

### 10.3.1 Performing Backup/Recovery

The suitable procedure for performing backup/recovery depends on your R&S SFE100 model.

- Models 02, 03: use the procedure described in [Chapter 10.3.2, "Recommended Procedure for the R&S SFE100 Models 02, 03"](#), on page 51.
- Models 12, 13: use the procedure described in [Chapter 10.3.3, "Windows XP Embedded Recovery and Backup Partition Dialog"](#), on page 51.

### 10.3.2 Recommended Procedure for the R&S SFE100 Models 02, 03

This procedure is performed by using the hardkeys and display on the front panel that are only provided by the models 02, 03. You do not need to connect an external monitor.

#### To restore the factory system partition

1. Switch the R&S SFE100 off and on again.  
While the boot screen is visible, the three LEDs on the front panel start blinking.
2. If a recovery is needed, press the BACK key within 4 seconds.  
The following message is displayed: "Restore factory default? Press OK to start restore."
3. Within the next 4 seconds, press OK. Otherwise the restore is skipped and the regular boot process continues.  
After pressing OK within 4 seconds, the recovery process starts and the following message is displayed: "Restore in progress! Please wait..."  
After the restore process is finished, a "warm boot" is carried out and R&S SFE100 continues with normal operation.

### 10.3.3 Windows XP Embedded Recovery and Backup Partition Dialog

Recommended procedure for the R&S SFE100 models 12, 13.

#### To display the Windows XP Embedded Recovery and Backup Partition dialog

1. Connect an external monitor, a keyboard and a mouse ([Chapter 6.3, "Connecting External Devices"](#), on page 29).
2. Switch the R&S SFE100 off and on again.  
The boot screen is displayed with the default selection "Firmware". If you do not perform [step 3](#) within 4 seconds, the dialog vanishes and the booting process continues.
3. Select "Backup/Recovery" and press ENTER.

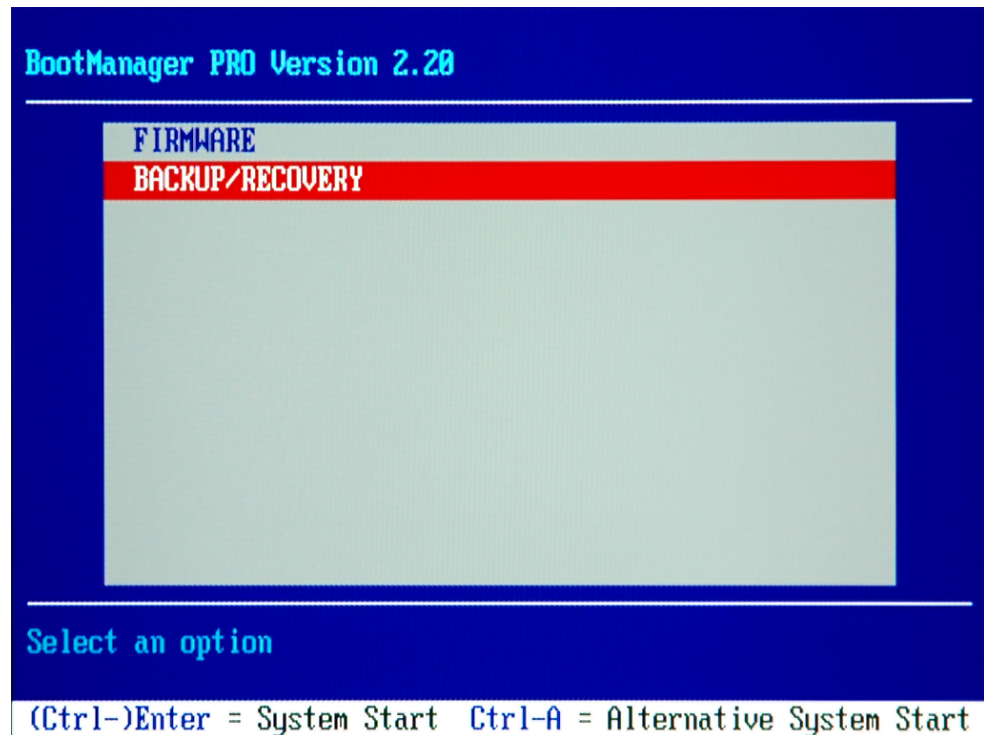

R&S SFE100 models 02, 03:

The recovery of the system partition factory version is started, see "[Important information for the R&S SFE100 models 02, 03](#)" on page 53.

R&S SFE100 models 12, 13:

The "Windows XP Recovery and Backup Embedded Partition" dialog is displayed. It shows the available selections for the recovery and backup partition.

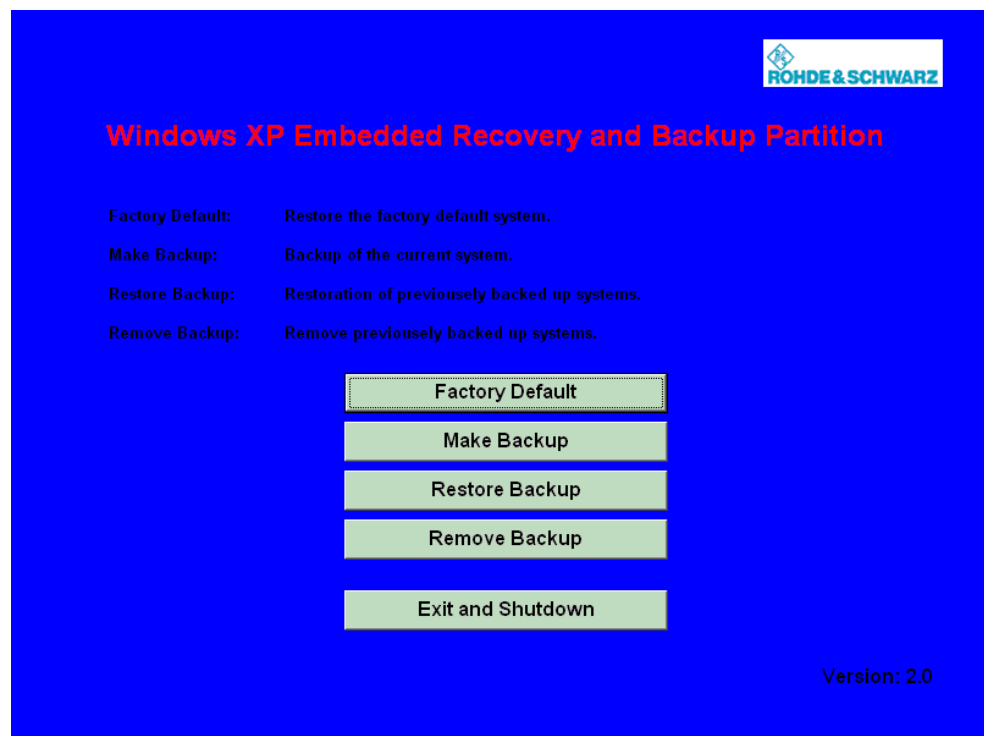

Figure 10-1: Windows XP Recovery and Backup Embedded Partition dialog

## NOTICE

### Important information for the R&S SFE100 models 02, 03

The recovery of the system partition factory version is running in the background (unattended). Do not prompt any actions before this process is completed. If the "Windows XP Recovery and Backup Embedded Partition" dialog is displayed (happens only if the installed image is older than LPCx\_SFE\_0024), you must not select "Factory Default" to avoid problems due to interference with the running background process.

For R&S SFE100 models 12/13, continue as described in one of the following chapters.

- The [Chapter 10.3.3.1, "Backing Up Current System Partition"](#), on page 53
- The [Chapter 10.3.3.2, "Recovering the Selected Version of System Partition"](#), on page 54
- The [Chapter 10.3.3.3, "Recovering the Factory Default"](#), on page 55
- The [Chapter 10.3.3.4, "Deleting Backups"](#), on page 56

### 10.3.3.1 Backing Up Current System Partition

Only R&S SFE100 models 12, 13.

1. In the "Windows XP Embedded Recovery and Backup Partition" dialog (see ["To display the Windows XP Embedded Recovery and Backup Partition dialog"](#) on page 51), click "Make Backup".

The "Make Backup" dialog is displayed. It shows the current versions of the firmware and the software platform.

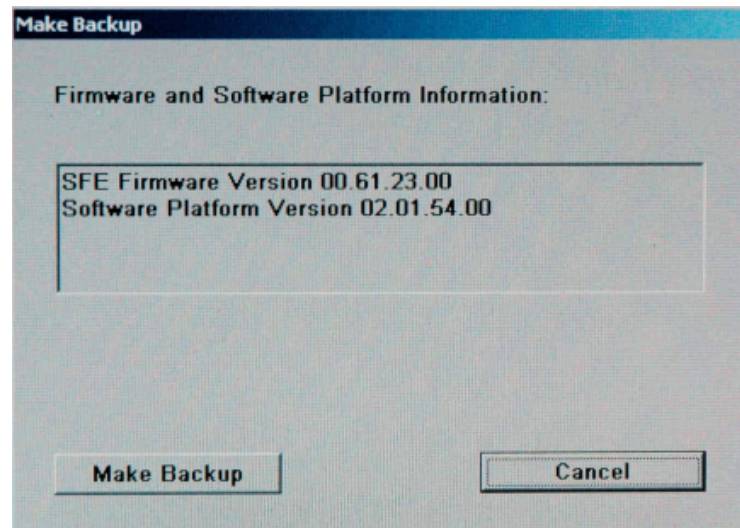

2. Click "Make Backup".  
After the backup, the "Windows XP Embedded Recovery and Backup Partition" dialog is displayed again.
3. Click "Exit and Shutdown".
4. Turn off/on the R&S SFE100 manually.

### 10.3.3.2 Recovering the Selected Version of System Partition

Only R&S SFE100 models 12, 13.

1. In the "Windows XP Embedded Recovery and Backup Partition" dialog (see ["To display the Windows XP Embedded Recovery and Backup Partition dialog"](#) on page 51), click "Restore Backup" to recover a selected version of the system partition.

The "Restore Backup" dialog is displayed. It shows the versions of the firmware and the software platform of the backup displayed under "Select Backup".



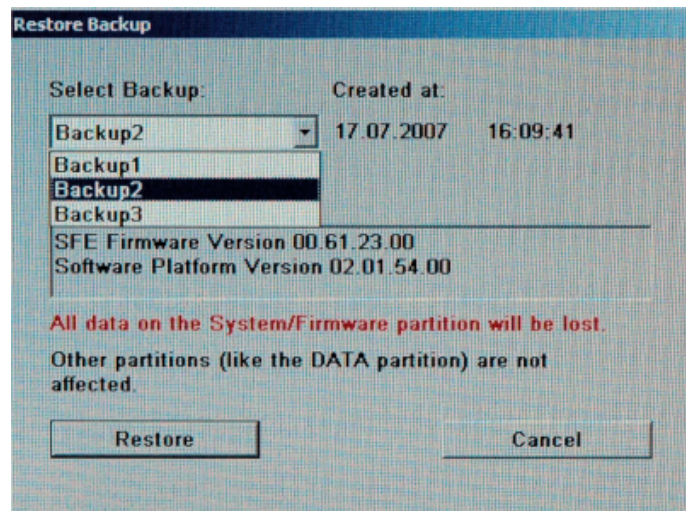

2. Under "Select Backup", select the backup to be restored.
3. Click "Restore" and follow the instructions.
4. After the recovery, turn off/on the R&S SFE100 manually.

### 10.3.3.3 Recovering the Factory Default

Only R&S SFE100 models 12, 13.

1. In the "Windows XP Embedded Recovery and Backup Partition" dialog (see ["To display the Windows XP Embedded Recovery and Backup Partition dialog"](#) on page 51), click "Factory Default" to recover the factory version of the system partition.

The "Factory Default" dialog is displayed. It shows the versions of the firmware and the software platform on delivery.

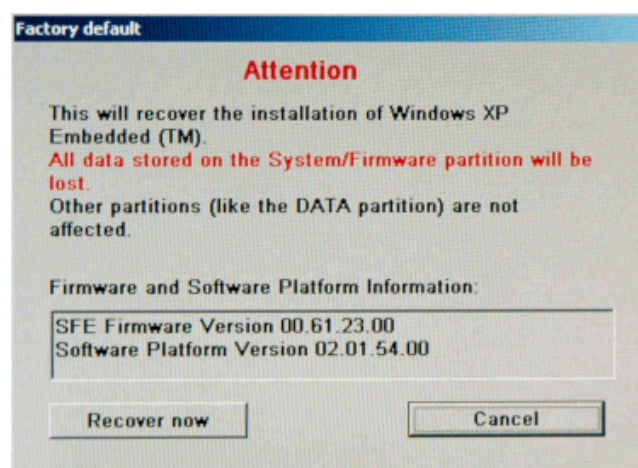

2. Click "Recover now" and follow the instructions.

3. After the recovery, turn off/on the R&S SFE100 manually.

#### 10.3.3.4 Deleting Backups

On the recovery partition, you can store up to five backups in addition to the factory default. To provide space for new backups, you may need to remove older backups. The factory default cannot be deleted.

Only R&S SFE100 models 12, 13.

1. In the "Windows XP Embedded Recovery and Backup Partition" dialog (see ["To display the Windows XP Embedded Recovery and Backup Partition dialog"](#) on page 51), click "Remove Backup" to delete a selected backup.

The "Remove Backup" dialog is displayed. It shows the versions of the firmware and the software platform of the selected backup.

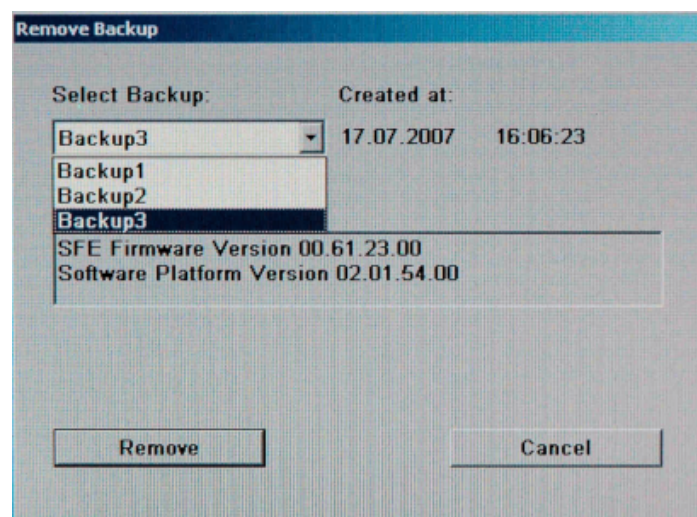

2. Under "Select Backup", select the backup to be deleted.
3. Click "Remove".

After the deletion, the R&S SFE100 returns to the "Remove Backup" dialog as long as backups are still available. If the last backup is deleted, the "Windows XP Embedded Recovery and Backup Partition" dialog is displayed again.
4. Click "Cancel" to return the "Windows XP Embedded Recovery and Backup Partition" dialog.
5. Click "Exit and Shutdown".
6. After the recovery, turn off/on the R&S SFE100 manually.

# 11 Maintenance

The R&S SFE100 does not need a periodic maintenance unless it is operated in dusty areas.

## NOTICE

### Risk of instrument damage

If the R&S SFE100 is operated in dusty areas, the fans may become obstructed by dust or other particles in the process of time. Make sure to check and, if necessary, clean the fans regularly to ensure they operate properly at all times. If the R&S SFE100 is run with obstructed fans for a longer period, it may become overheated which may cause damage.

Clean the outside of the instrument when necessary and check the rated data from time to time.

If any problem arises, contact one of our customer support centers. The addresses of our customer support centers are provided at the beginning of this manual.

## 11.1 Cleaning the Instrument

### WARNING

#### Shock hazard

Before cleaning the R&S SFE100, make sure that the R&S SFE100 is switched off and disconnected from all power supplies.

1. Clean the outside of the R&S SFE100 using a soft, lint-free dust cloth.
2. Make sure that vents are not obstructed.

## NOTICE

### Instrument damage caused by cleaning agents

Cleaning agents contain substances that may damage the R&S SFE100, e.g. cleaning agents that contain a solvent may damage the front panel labeling or plastic parts.

Never use cleaning agents such as solvents (thinners, acetone, etc), acids, bases, or other substances.

## 11.2 Replacing the Fuses

The R&S SFE100 is protected by two fuses (F1/F2: IEC127-T2.0H/250 V) located on the rear panel next to the AC power switch.

### **WARNING**

#### **Shock hazard**

Before replacing a fuse, make sure that the R&S SFE100 is switched off and disconnected from all power supplies.

Always use fuses supplied by Rohde & Schwarz as spare parts, or fuses of the same type and rating.

#### **To replace the fuses**

1. Open the lid of the AC power connector.
2. Lift the fuse holder out of its slot.
3. Exchange the two fuses.
4. Put the fuse holder back in its slot and close the lid.

## 11.3 Storing the Instrument

The storage temperature range of the R&S SFE100 is given in the data sheet. If the R&S SFE100 is to be stored for a longer period of time, it must be protected against dust.

Repack the R&S SFE100 as it was originally packed when transporting or shipping. The two protective foam plastic parts prevent the control elements and connectors from being damaged. The antistatic packing foil avoids any undesired electrostatic charging to occur.

If you do not use the original packaging, provide for sufficient padding to prevent the R&S SFE100 from slipping inside the package. Wrap antistatic packing foil around the R&S SFE100 to protect it from electrostatic charging.

# Index

## Symbols

1PPS / TRIG connector .....	26
100 BASE-T connector .....	23

## A

AC power supply	
connecting to .....	28
AC power supply connector .....	21
AC power switch .....	21
Administrator ID .....	49
Application cards .....	10
Application notes .....	10
AUDIO AUX connector .....	22

## B

BACK hardkey .....	18
Backing up system partition .....	50, 53
Bench operation .....	15
Brochures .....	10

## C

Checking	
accessories .....	15
provided options .....	34
Cleaning the instrument .....	57
Connecting	
external devices .....	29
power supply .....	28
Connector .....	23
1PPS / TRIG .....	26
100 BASE-T .....	23
AC power supply .....	21
AUDIO AUX .....	22
DIG I/Q IN .....	24
MONITOR .....	23
REF IN .....	26
RF OUT .....	19, 26
TS1 IN .....	21
TS2 IN .....	21
USB .....	20, 26
VIDEO IN .....	22
Conventions .....	7
Cursor keys .....	19

## D

Data sheets .....	10
Deleting system partition backups .....	56
Designated purpose .....	7
DIG I/Q IN connector .....	24
Display .....	19
DNARROW key .....	19
Documentation overview .....	9

## E

Electromagnetic interference .....	28
preventing .....	28
EMC precautions .....	28
External devices .....	29

External keyboard .....	30
External monitor .....	31

## F

Firewall settings .....	48
Firmware	
options .....	34
update .....	49
Front panel .....	17
Fuse	
replacing .....	58

## G

Getting started .....	9
-----------------------	---

## H

Hardkey	
BACK .....	18
LOCAL .....	18
OK .....	18
RF ON/OFF .....	18
Help .....	9

## I

Information	
Safety issues .....	7
IP address	
changing .....	47

## K

Key	
DNARROW .....	19
LEFTARROW .....	19
RIGHTARROW .....	19
see also "Hardkey" .....	19
UPARROW .....	19

## L

LAN connector .....	23
LEFTARROW key .....	19
Local area network (LAN) .....	23, 45
LOCAL hardkey .....	18
Login	
Windows XP .....	49

## M

Maintenance .....	57
Manual	
Getting started .....	9
User manual .....	9
Memory stick .....	31
MONITOR connector .....	23
Mouse .....	31

**N**

Network	
configuring card .....	47
connecting to .....	45
disconnecting from .....	45

**O**

OK hardkey .....	18
Open source acknowledgment (OSA) .....	10
Operating system .....	49
Options	
checking .....	34
firmware .....	34

**P**

Packing the instrument .....	58
Password	
Windows XP .....	49
POWER status display .....	18
Power supply	
connecting to .....	28
Product documentation .....	9
Provided options	
checking .....	34
Purpose .....	7
Putting up the instrument .....	15

**R**

Rack mounting .....	16
Rear panel .....	21
Recovering system partition .....	50
factory default .....	55
selected version .....	54
Recovery/backup partition dialog .....	51
REF IN connector .....	26
Release notes .....	10
REMOTE status display .....	18
Replacing fuses .....	58
RF ON status display .....	18
RF ON/OFF hardkey .....	18
RF OUT connector .....	19, 26
RIGHTARROW key .....	19

**S**

Safety information .....	7
Safety instructions .....	9
Shipping damage inspection .....	14
Software	
installing .....	50
Software options	
installing .....	49
Start menu .....	50
Status display	
POWER .....	18
REMOTE .....	18
RF ON .....	18
Storing the instrument .....	58
Switching on the instrument .....	33

**T**

TCP/IP protocol	
configuring .....	47
TS1 IN connector .....	21
TS2 IN connector .....	21
Tutorials .....	9

**U**

Unpacking the cardboard box .....	14
UPARROW key .....	19
USB connector .....	20, 26
external devices .....	29
User manual .....	9
User name	
Windows XP .....	49

**V**

VIDEO IN connector .....	22
--------------------------	----

**W**

Warranty .....	15
White papers .....	10
Windows XP .....	49
administrator ID .....	49
backing up system partition .....	53
deleting system partition backups .....	56
login .....	49
password .....	49
recovering system partition .....	54, 55
recovering/backing up system partition .....	50
recovery/backup partition dialog .....	51
Start menu .....	50
user name .....	49